



FMCOOA

Advanced OBDII tracker

Quick Manual v2.0

CONTENT

| | |
|--|----|
| Know your device..... | 3 |
| Pinout | 4 |
| Set up your device | 5 |
| PC Connection (Windows)..... | 6 |
| How to install USB drivers (Windows) | 6 |
| Configuration..... | 7 |
| Quick SMS configuration..... | 9 |
| Mounting recommendations..... | 11 |
| Basic characteristics | 12 |
| LED indications..... | 12 |
| Safety information | 15 |
| Certification and Approvals | 16 |
| Warranty | 18 |
| Warranty disclaimer | 18 |

KNOW YOUR DEVICE

TOP VIEW

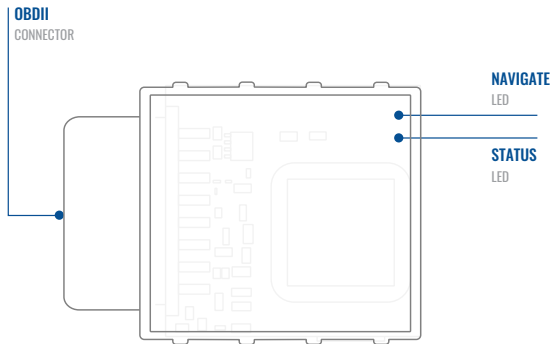

TOP VIEW (WITHOUT COVER)

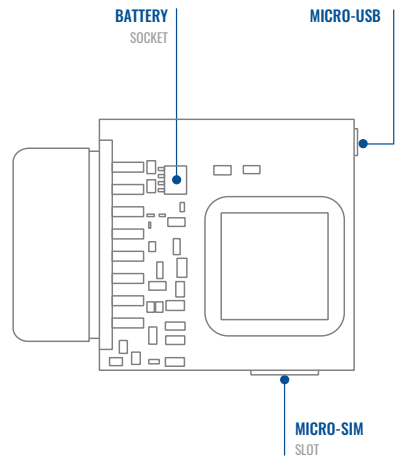

PINOUT

| PIN NUMBER | PIN NAME | DESCRIPTION |
|------------|----------------------|----------------------------|
| 2 | PWM_BUS+/VPW | |
| 4 | GND (-) | Ground |
| 5 | GND (-) | Ground |
| 6 | CAN_H | CAN high |
| 7 | K-Line | |
| 10 | PWM_BUS- | |
| 14 | CAN_L | CAN low |
| 15 | L-Line | |
| 16 | VCC (10 - 30)V DC(+) | Power supply (+10-30 V DC) |

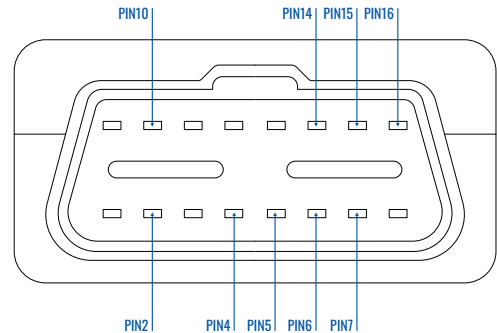

FMC00A OBDII socket pinout

SET UP YOUR DEVICE

HOW TO INSERT MICRO-SIM CARD AND CONNECT THE BATTERY

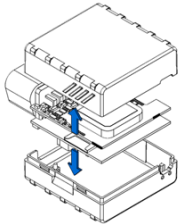

1 COVER REMOVAL

Gently remove FMC00A cover using plastic pry tool from both sides.

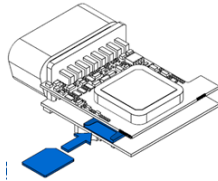

2 MICRO-SIM CARD INSERT

Insert **Micro-SIM** card as shown with **PIN request disabled** or read our [Wiki¹](#) how to enter it later in [Teltonika Configurator²](#). Make sure that Micro-SIM card **cut-off corner** is pointing forward to slot.

¹ wiki.teltonika-gps.com/view/FMC00A_Security_info

² wiki.teltonika.lt/view/Teltonika_Configurator

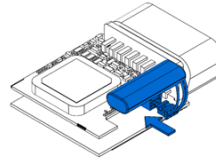

3 BATTERY CONNECTION

Connect **battery** as shown to device. Position the battery in place where it does not obstruct other components.

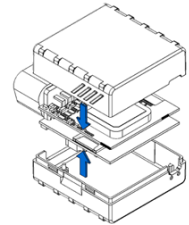

4 ATTACHING COVER BACK

Attach device **cover** back. Device is ready to be connected.

PC CONNECTION (WINDOWS)

1. Power-up FMC00A with **DC voltage (10 – 30 V)** power supply using **supplied power cable**. LED's should start blinking, see "**LED indications**".
2. Connect device to computer using **Micro-USB cable** or Bluetooth connection:
 - Using Micro-USB cable
 - You will need to install USB drivers, see "**How to install USB drivers (Windows)**"¹
 - Using **Bluetooth**
 - FMC00A **Bluetooth** is enabled by default. Turn on Bluetooth on your PC, then select **Add Bluetooth or other device > Bluetooth**. Choose your device named – "**FMC00A_last_7_imei_digits**", without LE in the end. Enter default password **5555**, press **Connect** and then select **Done**.
3. You are now ready to use the device on your computer.

¹wiki.teltonika-gps.com/view/FMC00A_LED_status

²Page 6, "How to install USB drivers"

HOW TO INSTALL USB DRIVERS (WINDOWS)

1. Please download COM port drivers from [here](#)¹.
2. Extract and run **TeltonikaCOMDriver.exe**.
3. Click **Next** in driver installation window.
4. In the following window click **Install** button.
5. Setup will continue installing the driver and eventually the confirmation window will appear. Click **Finish** to complete the setup.

¹teltonika-gps.com/downloads/en/fmb120/TeltonikaCOMDriver.zip

CONFIGURATION

At first FMC00A device will have default factory settings set. These settings should be changed according to the users needs. Main configuration can be performed via [Teltonika Configurator](#)¹ software. Get the latest **Configurator** version from [here](#)². Configurator operates on **Microsoft Windows OS** and uses prerequisite **MS .NET Framework**. Make sure you have the correct version installed.

¹ wiki.teltonika-gps.com/view/Teltonika_Configurator

² wiki.teltonika-gps.com/view/Teltonika_Configurator_versions

MS .NET REQUIREMENTS

| Operating system | MS .NET Framework version | Version | Links |
|------------------|---------------------------|---------------|---|
| Windows Vista | | | |
| Windows 7 | MS .NET Framework 4.6.2 | 32 and 64 bit | www.microsoft.com ¹ |
| Windows 8.1 | | | |
| Windows 10 | | | |

¹ dotnet.microsoft.com/en-us/download/dotnet-framework/net462

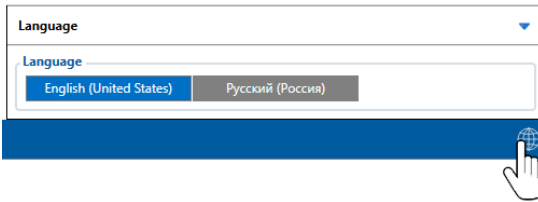

Downloaded Configurator will be in compressed archive. Extract it and launch Configurator.exe. After launch software language can be changed by clicking  in the right bottom corner.

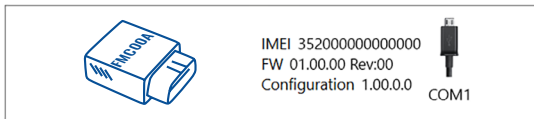



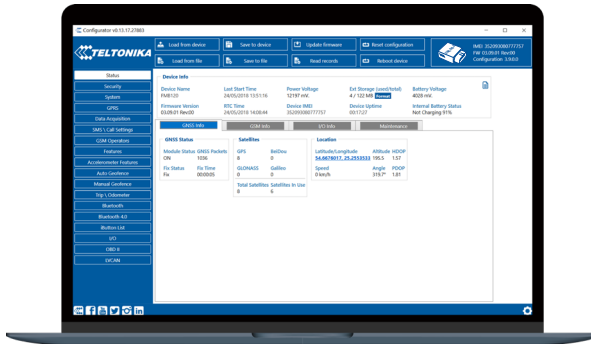





Configuration process begins by pressing on connected device.



After connection to Configurator **Status window** will be displayed.

Various **Status window**¹ tabs display information about **GNSS**², **GSM**³, **I/O**⁴, **Maintenance**⁵ and etc. FMC00A has one user editable profile, which can be loaded and saved to the device. After any modification of configuration the changes need to be saved to device using **Save to device** button. Main buttons offer following functionality:

-  **Load from device** – loads configuration from device.
-  **Save to device** – saves configuration to device.
-  **Load from file** – loads configuration from file.
-  **Save to file** – saves configuration to file.
-  **Update firmware** – updates firmware on device.
-  **Read records** – reads records from the device.
-  **Reboot device** – restarts device.
-  **Reset configuration** – sets device configuration to default.

Most important configurator section is **GPRS** – where all your server and **GPRS settings**⁶ can be configured and **Data Acquisition**⁷ – where data acquiring parameters can be configured. More details about FMC00A configuration using Configurator can be found in our [Wiki](#)⁸.

¹ wiki.teltonika-gps.com/view/FMC00A_Status_info

² wiki.teltonika-gps.com/view/FMC00A_Status_info#GNSS_Info

³ wiki.teltonika-gps.com/view/FMC00A_Status_info#GSM_Info

⁴ wiki.teltonika-gps.com/view/FMC00A_Status_info#I.2FO_Info

⁵ wiki.teltonika-gps.com/view/FMC00A_Status_info#Maintenance

⁶ wiki.teltonika-gps.com/index.php?title=FMC00A_GPRS_settings

⁷ wiki.teltonika-gps.com/index.php?title=FMC00A_Data_acquisition_settings

⁸ wiki.teltonika-gps.com/index.php?title=FMC00A_Configuration

QUICK SMS CONFIGURATION

Default configuration has optimal parameters present to ensure best performance of track quality and data usage.

Quickly set up your device by sending this SMS command to it:

```
« setparam 2001:APN;2002:APN_username;2003:APN_password;2004:Domain;2005:Port;2006:0»
```

1

2

3

4

5

6

Note: Before SMS text, two space symbols should be inserted.

GPRS SETTINGS:

- 1 2001 – APN
- 2 2002 – APN username (if there are no APN username, empty field should be left)
- 3 2003 – APN password (if there are no APN password, empty field should be left)

SERVER SETTINGS:

- 4 2004 – Domain
- 5 2005 – Port
- 6 2006 – Data sending protocol (0 – TCP, 1 – UDP)

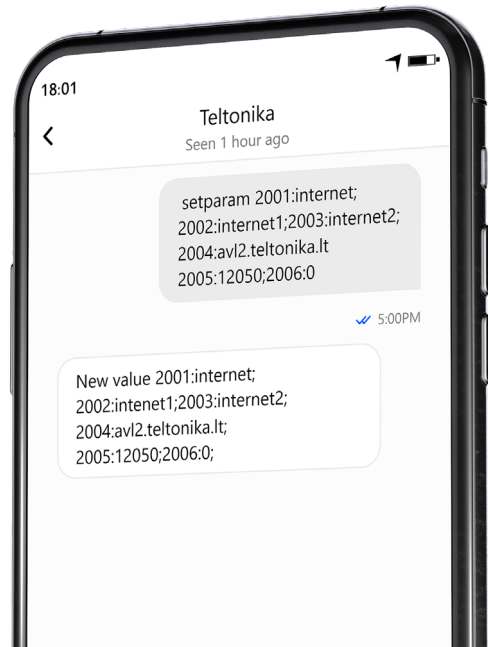

DEFAULT CONFIGURATION SETTINGS

MOVEMENT AND IGNITION DETECTION:



VEHICLE MOVEMENT
will be detected by
accelerometer



IGNITION
will be detected by
vehicle power voltage
between 13,2 – 30 V

DEVICE MAKES A RECORD ON STOP IF:



1 HOUR PASSES
while vehicle is
stationary and
ignition is off



EVERY 120 SECOND
it is sent to the server
If device has made a
record

DEVICE MAKES A RECORD ON MOVING IF ONE OF THESE EVENTS HAPPEN:



PASSES
300 seconds



VEHICLE DRIVES
100 meters



VEHICLE TURNS
10 degrees



SPEED DIFFERENCE
between last coordinate
and current position is
greater than 10 km/h

After successful SMS configuration, FMC00A device will synchronize time and update records to configured server. Time intervals and default I/O elements can be changed by using [Teltonika Configurator¹](#) or [SMS parameters²](#).

¹ wiki.teltonika-gps.com/view/Teltonika_Configurator

² wiki.teltonika-gps.com/view/Template:FMB_Device_Family_Parameter_list

MOUNTING RECOMMENDATIONS

CONNECTING THE DEVICE TO THE VEHICLE:

Find OBDII connector in your vehicle.

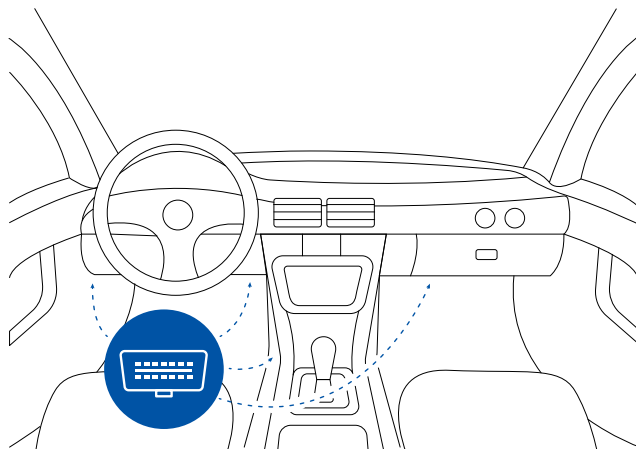

Most common OBDII connector locations.

LED INDICATIONS

NAVIGATION LED INDICATIONS

| BEHAVIOUR | MEANING |
|--------------------------|---|
| Permanently switched on | GNSS signal is not received |
| Blinking every second | Normal mode, GNSS is working |
| Off | GNSS is turned off because: Device is not working or Device is in sleep mode |
| Blinking fast constantly | Device firmware is being flashed |

STATUS LED INDICATIONS

| BEHAVIOUR | MEANING |
|--------------------------------|---|
| Blinking every second | Normal mode |
| Blinking every two seconds | Sleep mode |
| Blinking fast for a short time | Modem activity |
| Off | Device is not working or Device is in boot mode |

BASIC CHARACTERISTICS

MODULE

| | |
|------------|-----------------------------------|
| Name | Quectel EG91-NA, Teltonika TM2500 |
| Technology | LTE(CAT1)/UMTS/GNSS/BLUETOOTH |

GNSS

| | |
|----------------------|---|
| GNSS | GPS, GLONASS, GALILEO, BEIDOU, SBAS, QZSS, DGPS, AGPS |
| Receiver | 33 channel |
| Tracking sensitivity | -165 dBm |
| Accuracy | < 3 m |
| Hot start | < 1 s |
| Warm start | < 25 s |
| Cold start | < 35 s |

CELLUAR

| | |
|------------|---------------------------|
| Technology | LTE CAT 1, UMTS |
| 3G bands | WCDMA: B2/B4/B5 |
| 4G bands | LTE FDD: B2/B4/B5/B12/B13 |

| | |
|----------------|---|
| Data transfer | LTE: LTE FDD: Max 10Mbps (DL)/ Max 5Mbps (UL) UMTS: WCDMA: Max 384Kbps (DL)/ Max 384 Kbps (UL) |
| Transmit power | Class 3 for LTE-FDD: 23±1dBm Class 3 for WCDMA: 23.5±1dBm |
| Data support | SMS (text/data) |

POWER

| | |
|---------------------|---|
| Input voltage range | 10 - 30 V DC with overvoltage protection |
| Back-up battery | 115 mAh Li-Po battery 3.7 V (0.43 Wh) |
| Internal fuse | 3A, 125V |
| Power Consumption | At 12V < 6.5 mA (Ultra Deep Sleep) |
| | At 12V < 8 mA (Deep Sleep) |
| | At 12V < 13 mA (Online Deep Sleep) |
| | At 12V < 16.3 mA (GPS Sleep) |
| | At 12V < 31 mA (nominal with no load) |
| | At 12V < 0.25A Max. (with full Load / Peak) |

BLUETOOTH

| | |
|---------------|----------|
| Specification | 4.0 + LE |
|---------------|----------|

Supported peripherals

Temperature and Humidity sensor¹, Inateck Barcode Scanner, Universal BLE sensors support

OBD INTERFACE

| | |
|--------------|--|
| Data | K-Line, CAN Bus data |
| Data reading | Up to 32 vehicle onboard parameters, 9 supported OBD protocols |

INTERFACE

| | |
|----------------|-----------------------------|
| Connection | OBDII socket |
| GNSS antenna | Internal High Gain |
| GSM antenna | Internal High Gain |
| USB | 2.0 Micro-USB |
| LED indication | 2 status LED lights |
| SIM | Micro-SIM |
| Memory | 128MB internal flash memory |

PHYSICAL SPECIFICATION

| | |
|------------|---------------------------------|
| Dimensions | 67,2 x 49,6 x 25 mm (L x W x H) |
| Weight | 63 g |

¹ <https://teltonika.lt/product/bluetooth-sensor/>

OPERATING ENVIRONMENT

| | |
|---|---|
| Operating temperature (without battery) | -40 °C to +85 °C |
| Storage temperature (without battery) | -40 °C to +85 °C |
| Operating temperature (with battery) | 0 °C to +45 °C |
| Storage temperature (with battery) | -20 °C to +45 °C for 1 month -20 °C to +35 °C for 6 months |
| Operating humidity | 5% to 95% non-condensing |
| Ingress Protection Rating | IP41 |
| Battery charge temperature | 0 °C to +45 °C |
| Battery discharge temperature | -20 °C to +60 °C |
| Battery storage temperature | -20 °C to +45 °C for 1 month -20 °C to +35 °C for 6 months |

FEATURES

| | |
|---------|---------------|
| Sensors | Accelerometer |
|---------|---------------|

| | |
|-----------------------------------|--|
| Scenarios | Green Driving, Over Speeding detection, Jamming detection, GNSS Fuel Counter, Excessive Idling detection, Unplug detection, Towing detection, Crash detection, Auto Geofence, Manual Geofence, Trip ² |
| Sleep modes | GPS Sleep, Online Deep Sleep, Deep Sleep, Ultra Deep Sleep ³ |
| Configuration and firmware update | FOTA Web ⁴ , FOTA ⁵ , Teltonika Configurator ⁶ (USB, Bluetooth), FMBT mobile application ⁷ (Configuration) |
| SMS | Configuration, Events, Debug |
| GPRS commands | Configuration, Debug |
| Time Synchronization | GPS, NITZ, NTP |
| Fuel monitoring | OBDII |
| Ignition detection | Accelerometer, External Power Voltage, Engine RPM |

²wiki.teltonika-gps.com/view/FMC00A_Features_settings

³wiki.teltonika-gps.com/view/FMC00A_Sleep_modes#Deep_Sleep_mode

⁴wiki.teltonika-gps.com/view/FOTA_WEB

⁵wiki.teltonika-gps.com/view/FOTA

⁶wiki.teltonika-gps.com/view/Teltonika_Configurator

⁷wiki.teltonika-gps.com/view/FMBT_Mobile_application

SAFETY INFORMATION

This message contains information on how to operate FMC00A safely. By following these requirements and recommendations, you will avoid dangerous situations. You must read these instructions carefully and follow them strictly before operating the device!

- The device uses SELV limited power source. The nominal voltage is +12 V DC. The allowed voltage range is +10...+30 V DC.
- To avoid mechanical damage, it is advised to transport the device in an impact-proof package. Before usage, the device should be placed so that its LED indicators are visible. They show the status of device operation.
- Before unmounting the device from vehicle, ignition **MUST** be **OFF**.



Do not disassemble the device. If the device is damaged, the power supply cables are not isolated or the isolation is damaged, **DO NOT** touch the device before unplugging the power supply.



All wireless data transferring devices produce interference that may affect other devices which are placed nearby.



Please consult representatives of your vehicle model regarding OBDII location on your vehicle. In case you are not sure about proper connection, please consult qualified personnel.



The programming must be performed using a PC with autonomic power supply.



Installation and/or handling during a lightning storm is prohibited.



The device is susceptible to water and humidity.



Teltonika is not responsible for any harm caused by wrong cables used for connection between PC and FMC00A



WARNING! Do not use FMC00A device if it distracts driver or causes inconvenience due to OBDII placement. Device must not interfere with driver.



Battery should not be disposed of with general household waste. Bring damaged or worn-out batteries to your local recycling center or dispose them to battery recycle bin found in stores.

CERTIFICATION AND APPROVALS



This sign on the package means that it is necessary to read the User's Manual before you start using the device. Full User's Manual version can be found in our [Wiki](#)¹.

¹ wiki.teltonika-gps.com/index.php?title=FMC00A



This sign on the package means that all used electronic and electric equipment should not be mixed with general household waste.



The [RoHS](#)¹ is a directive regulating the manufacture, import and distribution of Electronics and Electrical Equipment (EEE) within the EU, which bans from use 10 different hazardous materials (to date).

¹ wiki.teltonika-gps.com/view/FMC00A_RoHS



FCC ID:2A3HUFMC00A.

- This device complies with part 15 of the FCC Rules. Operation is subject to the following two conditions: (1) This device may not cause harmful interference, and (2) this device must accept any interference received, including interference that may cause undesired operation.
- This equipment has been tested and found to comply with the limits for a Class B digital device, pursuant to part 15 of the FCC Rules.

These limits are designed to provide reasonable protection against harmful interference in a residential installation. This equipment generates, uses and can radiate radio frequency energy and, if not installed and used in accordance with the instructions, may cause harmful interference to radio communications. However, there is no guarantee that interference will not occur in a particular installation. If this equipment does cause harmful interference to radio or television reception, which can be determined by turning the equipment off and on, the user is encouraged to try to correct the interference by one or more of the following measures:

- Reorient or relocate the receiving antenna.
- Increase the separation between the equipment and receiver.
- Connect the equipment into an outlet on a circuit different from that to which the receiver is connected.
- Consult the dealer or an experienced radio/ TV technician for help.
- Changes or modifications not expressly approved by the manufacturer could void the user's authority to operate the equipment.
- This equipment complies with FCC radiation exposure limits set forth for an uncontrolled environment. To comply with FCC RF Exposure compliance requirements, this grant is applicable to only Mobile Configurations. The antennas used for the transmitter must be installed to provide a separation distance of at least 20cm from all persons and must not be co-located or operating in conjunction with any other antenna or transmitter.



IC NOTICE

This device complies with Industry Canada license-exempt RSS standard(s). Operation is subject to the following two conditions:

1. this device may not cause interference, and
2. this device must accept any interference, including interference that may cause undesired operation of the device.

This Class B digital apparatus complies with Canadian ICES-003.

IC: 28804-FMC00A.

This equipment complies with ISED radiation exposure limits set forth for an uncontrolled environment. To comply with RSS-102 RF Exposure compliance requirements, this grant is applicable to only Mobile Configurations. The antennas used for the transmitter must be installed to provide a separation distance of at least 20cm from all persons and must not be co-located or operating in conjunction with any other antenna or transmitter.

REMARQUE IC

Cet appareil est conforme aux Normes RSS d'Industry Canada. Son utilisation est soumise à deux conditions:

3. Ce dispositif ne peut pas provoquer d'interférences, et
4. Ce dispositif doit accepter toutes les interférences reçues, y compris les interférences susceptibles de provoquer un fonctionnement non souhaité.

Cet appareil de classe B est conforme à la norme canadienne ICES-003.

IC: 28804-FMC00A.

Cet équipement est conforme aux limites d'exposition aux rayonnements ISED établies pour un environnement non contrôlé. Pour se conformer aux exigences de conformité d'exposition aux radiofréquences RSS-102, cette subvention s'applique uniquement aux configurations mobiles. Les antennes utilisées pour l'émetteur doivent être installées pour fournir une distance de séparation d'au moins 20cm de toutes les personnes et ne doivent pas être co-localisées ou fonctionner en conjonction avec une autre antenne ou émetteur.

CHECK ALL CERTIFICATES

All newest certificates may be found in our [Wiki](#)².

² wiki.teltonika-gps.com/view/FMC00A_Certification_%26_Approvals

WARRANTY

We guarantee our products 24-month warranty¹ period.

All batteries carry a 6-month warranty period.

Post-warranty repair service for products is not provided.

If a product stops operating within this specific warranty time, the product can be:

- Repaired
- Replaced with a new product
- Replaced with an equivalent repaired product fulfilling the same functionality
- Replaced with a different product fulfilling the same functionality in case of EOL for the original product

¹ Additional agreement for an extended warranty period can be agreed upon separately.

WARRANTY DISCLAIMER

- Customers are only allowed to return products as a result of the product being defective, due to order assembly or manufacturing fault.
- Products are intended to be used by personnel with training and experience.
- Warranty does not cover defects or malfunctions caused by accidents, misuse, abuse, catastrophes, improper maintenance or inadequate installation – not following operating instructions (including failure to heed warnings) or use with equipment with which it is not intended to be used.
- Warranty does not apply to any consequential damages.
- Warranty is not applicable for supplementary product equipment (i. e. PSU, power cables, antennas) unless the accessory is defective on arrival.
- [More information on what is RMA¹](#)

¹ wiki.teltonika-gps.com/view/RMA_guidelines