



# FMCO03

---

Advanced OBDII tracker

Quick Manual v1.1

# CONTENT

Know your device.....	3
Pinout .....	4
Set up your device .....	5
PC Connection (Windows).....	6
How to install USB drivers (Windows) .....	6
Configuration.....	7
Quick SMS configuration.....	9
Mounting recommendations.....	11
Basic characteristics .....	12
LED indications.....	12
Safety information .....	16
Certification and Approvals .....	17
Warranty .....	18
Warranty disclaimer .....	18

# KNOW YOUR DEVICE

## TOP VIEW

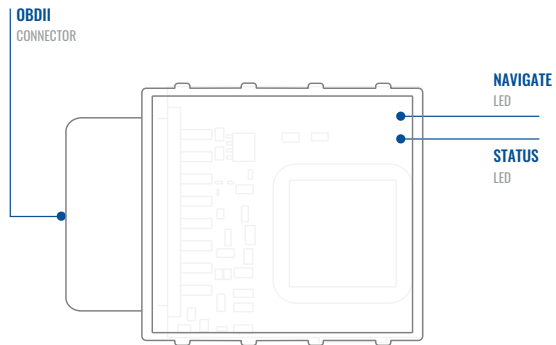

## TOP VIEW (WITHOUT COVER)

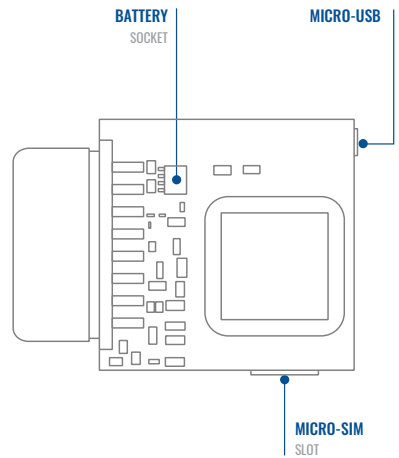

# PINOUT

Pin number	Pin name	Description
2	PWM_BUS+/VPW	
4	GND (-)	Ground
5	GND (-)	Ground
6	CAN_H	CAN high
7	K-Line	
10	PWM_BUS-	
14	CAN_L	CAN low
15	L-Line	
16	VCC (10 - 30)V DC(+)	Power supply (+10-30 V DC)

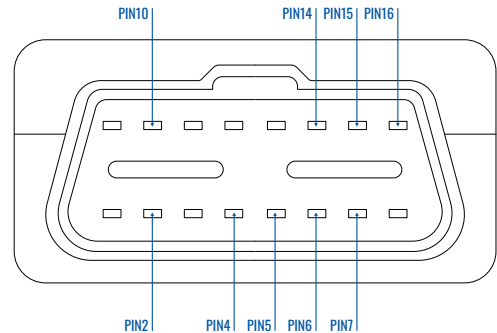

FMC003 OBDII socket pinout

# SET UP YOUR DEVICE

## HOW TO INSERT MICRO-SIM CARD AND CONNECT THE BATTERY

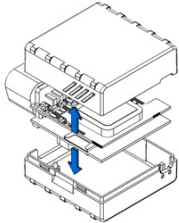

### 1 COVER REMOVAL

Gently remove FMC003 cover using plastic pry tool from both sides.

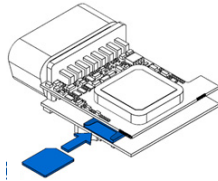

### 2 MICRO-SIM CARD INSERT

Insert **Micro-SIM** card as shown with **PIN request disabled** or read our [Wiki<sup>1</sup>](#) how to enter it later in [Teltonika Configurator<sup>2</sup>](#). Make sure that Micro-SIM card **cut-off corner** is pointing forward to slot.

<sup>1</sup> [wiki.teltonika-gps.com/view/FMC003\\_Security\\_info](http://wiki.teltonika-gps.com/view/FMC003_Security_info)

<sup>2</sup> [wiki.teltonika.lt/view/Teltonika\\_Configurator](http://wiki.teltonika.lt/view/Teltonika_Configurator)

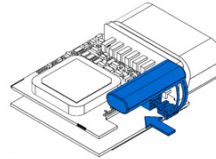

### 3 BATTERY CONNECTION

Connect **battery** as shown to device. Position the battery in place where it does not obstruct other components.

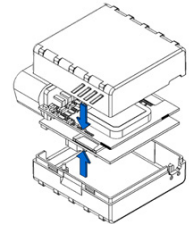

### 4 ATTACHING COVER BACK

Attach device **cover** back. Device is ready to be connected.

# PC CONNECTION (WINDOWS)

1. Power-up FMC003 with **DC voltage (10 – 30 V)** power supply using **supplied power cable**. LED's should start blinking, see "**LED indications**".
2. Connect device to computer using **Micro-USB cable** or Bluetooth connection:
  - Using Micro-USB cable
    - You will need to install USB drivers, see "**How to install USB drivers (Windows)**"<sup>2</sup>
  - Using **Bluetooth**
    - FMC003 **Bluetooth** is enabled by default. Turn on Bluetooth on your PC, then select **Add Bluetooth or other device > Bluetooth**. Choose your device named – "**FMC003\_last\_7\_imei\_digits**", without **LE** in the end. Enter default password **5555**, press **Connect** and then select **Done**.
3. You are now ready to use the device on your computer.

<sup>1</sup>[wiki.teltonika-gps.com/view/FMC003\\_LED\\_status](http://wiki.teltonika-gps.com/view/FMC003_LED_status)

<sup>2</sup>Page 6, "How to install USB drivers"

# HOW TO INSTALL USB DRIVERS (WINDOWS)

1. Please download COM port drivers from [here](#)<sup>1</sup>.
2. Extract and run **TeltonikaCOMDriver.exe**.
3. Click **Next** in driver installation window.
4. In the following window click **Install** button.
5. Setup will continue installing the driver and eventually the confirmation window will appear. Click **Finish** to complete the setup.

<sup>1</sup>[teltonika-gps.com/downloads/en/fmb120/TeltonikaCOMDriver.zip](http://teltonika-gps.com/downloads/en/fmb120/TeltonikaCOMDriver.zip)

# CONFIGURATION

At first FMC003 device will have default factory settings set. These settings should be changed according to the users needs. Main configuration can be performed via [Teltonika Configurator](#)<sup>1</sup> software. Get the latest **Configurator** version from [here](#)<sup>2</sup>. Configurator operates on **Microsoft Windows OS** and uses prerequisite **MS .NET Framework**. Make sure you have the correct version installed.

<sup>1</sup> [wiki.teltonika-gps.com/view/Teltonika\\_Configurator](http://wiki.teltonika-gps.com/view/Teltonika_Configurator)

<sup>2</sup> [wiki.teltonika-gps.com/view/Teltonika\\_Configurator\\_versions](http://wiki.teltonika-gps.com/view/Teltonika_Configurator_versions)

## MS .Net requirements

Operating system	MS .NET Framework version	Version	Links
Windows Vista			
Windows 7			
Windows 8.1	MS .NET Framework 4.6.2	32 and 64 bit	<a href="http://www.microsoft.com">www.microsoft.com</a> <sup>1</sup>
Windows 10			

<sup>1</sup> [dotnet.microsoft.com/en-us/download/dotnet-framework/net462](http://dotnet.microsoft.com/en-us/download/dotnet-framework/net462)

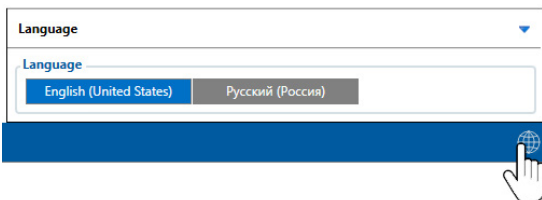

Downloaded Configurator will be in compressed archive. Extract it and launch Configurator.exe. After launch software language can be changed by clicking  in the right bottom corner.





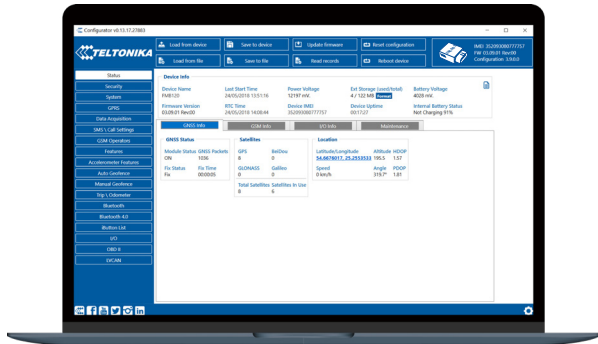





Configuration process begins by pressing on connected device.



After connection to Configurator **Status window** will be displayed.

Various **Status window**<sup>1</sup> tabs display information about **GNSS**<sup>2</sup>, **GSM**<sup>3</sup>, **I/O**<sup>4</sup>, **Maintenance**<sup>5</sup> and etc. FMC003 has one user editable profile, which can be loaded and saved to the device. After any modification of configuration the changes need to be saved to device using **Save to device** button. Main buttons offer following functionality:

-  **Load from device** – loads configuration from device.
-  **Save to device** – saves configuration to device.
-  **Load from file** – loads configuration from file.
-  **Save to file** – saves configuration to file.
-  **Update firmware** – updates firmware on device.
-  **Read records** – reads records from the device.
-  **Reboot device** – restarts device.
-  **Reset configuration** – sets device configuration to default.

Most important configurator section is **GPRS** – where all your server and **GPRS settings**<sup>6</sup> can be configured and **Data Acquisition**<sup>7</sup> – where data acquiring parameters can be configured. More details about FMC003 configuration using Configurator can be found in our **Wiki**<sup>8</sup>.

<sup>1</sup> [wiki.teltonika-gps.com/view/FMC003\\_Status\\_info](http://wiki.teltonika-gps.com/view/FMC003_Status_info)

<sup>2</sup> [wiki.teltonika-gps.com/view/FMC003\\_Status\\_info#GNSS\\_Info](http://wiki.teltonika-gps.com/view/FMC003_Status_info#GNSS_Info)

<sup>3</sup> [wiki.teltonika-gps.com/view/FMC003\\_Status\\_info#GSM\\_Info](http://wiki.teltonika-gps.com/view/FMC003_Status_info#GSM_Info)

<sup>4</sup> [wiki.teltonika-gps.com/view/FMC003\\_Status\\_info#I2FO\\_Info](http://wiki.teltonika-gps.com/view/FMC003_Status_info#I2FO_Info)

<sup>5</sup> [wiki.teltonika-gps.com/view/FMC003\\_Status\\_info#Maintenance](http://wiki.teltonika-gps.com/view/FMC003_Status_info#Maintenance)

<sup>6</sup> [wiki.teltonika-gps.com/index.php?title=FMC003\\_GPRS\\_settings](http://wiki.teltonika-gps.com/index.php?title=FMC003_GPRS_settings)

<sup>7</sup> [wiki.teltonika-gps.com/index.php?title=FMC003\\_Data\\_acquisition\\_settings](http://wiki.teltonika-gps.com/index.php?title=FMC003_Data_acquisition_settings)

<sup>8</sup> [wiki.teltonika-gps.com/index.php?title=FMC003\\_Configuration](http://wiki.teltonika-gps.com/index.php?title=FMC003_Configuration)



# QUICK SMS CONFIGURATION

Default configuration has optimal parameters present to ensure best performance of track quality and data usage.

Quickly set up your device by sending this SMS command to it:

```
« setparam 2001:APN;2002:APN_username;2003:APN_password;2004:Domain;2005:Port;2006:0»
```

1

2

3

4

5

6

**Note:** Before SMS text, two space symbols should be inserted.

## GPRS SETTINGS:

- 1 2001 – APN
- 2 2002 – APN username (if there are no APN username, empty field should be left)
- 3 2003 – APN password (if there are no APN password, empty field should be left)

## SERVER SETTINGS:

- 4 2004 – Domain
- 5 2005 – Port
- 6 2006 – Data sending protocol (0 – TCP, 1 – UDP)

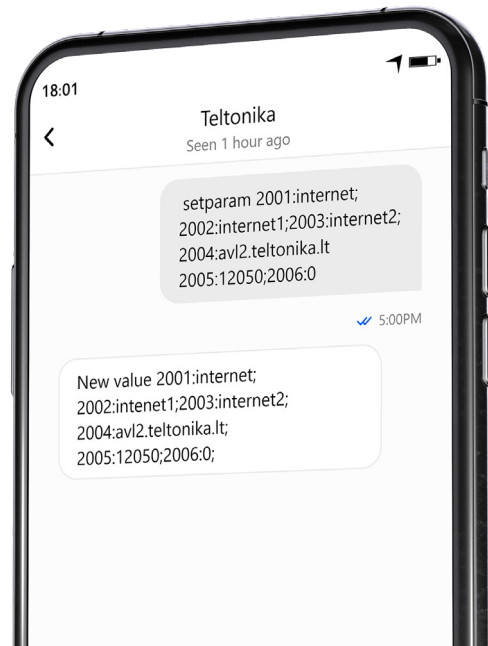

## DEFAULT CONFIGURATION SETTINGS

### MOVEMENT AND IGNITION DETECTION:



**VEHICLE MOVEMENT**  
will be detected by  
accelerometer



**IGNITION**  
will be detected by  
vehicle power voltage  
between 13,2 – 30 V

### DEVICE MAKES A RECORD ON STOP IF:



**1 HOUR PASSES**  
while vehicle is  
stationary and  
ignition is off



**EVERY 120 SECOND**  
it is sent to the server  
If device has made a  
record

### DEVICE MAKES A RECORD ON MOVING IF ONE OF THESE EVENTS HAPPEN:



**PASSES**  
300 seconds



**VEHICLE DRIVES**  
100 meters



**VEHICLE TURNS**  
10 degrees



**SPEED DIFFERENCE**  
between last coordinate  
and current position is  
greater than 10 km/h

After successful SMS configuration, FMC003 device will synchronize time and update records to configured server. Time intervals and default I/O elements can be changed by using [Teltonika Configurator](#)<sup>1</sup> or [SMS parameters](#)<sup>2</sup>.

<sup>1</sup> [wiki.teltonika-gps.com/view/Teltonika\\_Configurator](http://wiki.teltonika-gps.com/view/Teltonika_Configurator)

<sup>2</sup> [wiki.teltonika-gps.com/view/Template:FMB\\_Device\\_Family\\_Parameter\\_list](http://wiki.teltonika-gps.com/view/Template:FMB_Device_Family_Parameter_list)

# MOUNTING RECOMMENDATIONS

## CONNECTING THE DEVICE TO THE VEHICLE:

Find OBDII connector in your vehicle.

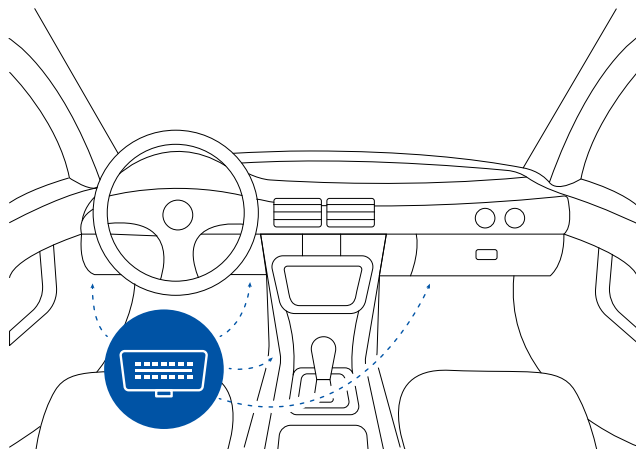

Most common OBDII connector locations.

# LED INDICATIONS

## NAVIGATION LED INDICATIONS

Behaviour	Meaning
Permanently switched on	GNSS signal is not received
Blinking every second	Normal mode, GNSS is working
Off	GNSS is turned off because: Device is not working or Device is in sleep mode
Blinking fast constantly	Device firmware is being flashed

## STATUS LED INDICATIONS

Behaviour	Meaning
Blinking every second	Normal mode
Blinking every two seconds	Sleep mode
Blinking fast for a short time	Modem activity
Off	Device is not working or Device is in boot mode

# BASIC CHARACTERISTICS

## Module

Name	MeiG SLM320-L16A, MeiG SLM320-PE2C, Teltonika TM2500
Technology	LTE(CAT1)/2G(GSM/GPRS)/GNSS/BLUETOOTH

## GNSS

GNSS	GPS, GLONASS, GALILEO, BEIDOU, SBAS, QZSS, DGPS, AGPS
Receiver	33 channel
Tracking sensitivity	-165 dBm
Accuracy	< 3 m
Hot start	< 1 s
Warm start	< 25 s
Cold start	< 35 s

## Celluar

Technology	LTE CAT 1, GSM
2G bands	MeiG SLM320-PE2C: GSM: B2/B3/B5/B8 MeiG SLM320-L16A: GSM: B2/B3/B5/B8

4G bands	MeiG SLM320-PE2C: MeiG SLM320-PE2C LTE-FDD: B1/B3/B7/B8/B20/B28 LTE-TDD:B38/B40/B41 MeiG SLM320-L16A: LTE FDD: B1/B2/B3/B4/B5/B7/B8/B20/B28 LTE-TDD:B40
Data transfer	LTE: LTE FDD: Max 10Mbps (DL)/Max 5Mbps (UL) LTE TDD: Max 8Mbps (DL)/Max 2Mbps (UL) GSM: GPRS: Max 85.6Kbps (DL)/Max 85.6Kbps (UL)
Transmit power	Class 4 for GSM850/900: 23±2dBm Class 1 for GSM1800/1900: 20±2dBm Class 3 for LTE-TDD: 23±2.7dBm Class 3 for LTE-FDD: 23±2.7dBm
Data support	SMS (text/data)

## Power

Input voltage range	10 - 30 V DC with overvoltage protection
Back-up battery	170 mAh Li-Po battery 3.7 V (0.63 Wh)
Internal fuse	3A, 125V

Power Consumption	At 12V < 6.5 mA (Ultra Deep Sleep)
	At 12V < 8 mA (Deep Sleep)
	At 12V < 13 mA (Online Deep Sleep)
	At 12V < 16.3 mA (GPS Sleep)
	At 12V < 31 mA (nominal with no load)
	At 12V < 0.25A Max. (with full Load / Peak)

## Bluetooth

Specification	4.0 + LE
Supported peripherals	<b>Temperature and Humidity sensor<sup>1</sup></b> , Inateck Barcode Scanner, Universal BLE sensors support

## OBD Interface

Data	HS CAN, MS CAN, SW CAN, K-line
------	--------------------------------

<sup>1</sup> <https://teltonika.lt/product/bluetooth-sensor/>

	OEM Fuel level, odometer and up to 32 vehicle onboard parameters, supported OBD protocols:
	ISO 9141-2 (5 baud init, 10.4 kbaud)
	ISO 14230-4 KWP (5 baud init, 10.4 kbaud)
	ISO 14230-4 KWP (fast init, 10.4 kbaud)
Data reading	ISO 15765-4 CAN (11 bit ID, 250 kbaud)
	ISO 15765-4 CAN (11 bit ID, 500 kbaud)
	ISO 15765-4 CAN (29 bit ID, 250 kbaud)
	ISO 15765-4 CAN (29 bit ID, 500 kbaud)
	ISO 14229 (UDS)
	J2819 (VW TP2.0)

## Interface

Connection	OBDII socket
GNSS antenna	Internal High Gain
GSM antenna	Internal High Gain
USB	2.0 Micro-USB
LED indication	2 status LED lights
SIM	Micro-SIM
Memory	128MB internal flash memory

## Physical Specification

Dimensions	67,2 x 49,6 x 25 mm (L x W x H)
Weight	63 g

## Operating Environment

Operating temperature (without battery)	-40 °C to +85 °C
Storage temperature (without battery)	-40 °C to +85 °C
Operating humidity	5% to 95% non-condensing
Operating Temperature (with battery)	-20C to + 40C
Ingress Protection Rating	IP41
Battery charge temperature	0 °C to +45 °C
Battery discharge temperature	-20 °C to +60 °C
Battery storage temperature	-20 °C to +45 °C for 1 month -20 °C to +35 °C for 6 months

## Features

Sensors	Accelerometer
---------	---------------

Scenarios	<b>Green Driving, Over Speeding detection, Jamming detection, GNSS Fuel Counter, Excessive Idling detection, Unplug detection, Towing detection, Crash detection, Auto Geofence, Manual Geofence, Trip<sup>2</sup></b>
Sleep modes	<b>GPS Sleep, Online Deep Sleep, Deep Sleep, Ultra Deep Sleep<sup>3</sup></b>
Configuration and firmware update	<b>FOTA Web<sup>4</sup>, FOTA<sup>5</sup>, Teltonika Configurator<sup>6</sup> (USB, Bluetooth), FMBT mobile application<sup>7</sup> (Configuration)</b>
SMS	Configuration, Events, Debug
GPRS commands	Configuration, Debug
Time Synchronization	GPS, NITZ, NTP
Fuel monitoring	OBDII
Ignition detection	Accelerometer, External Power Voltage, Engine RPM

<sup>2</sup>[wiki.teltonika-gps.com/view/FMC003\\_Features\\_settings](http://wiki.teltonika-gps.com/view/FMC003_Features_settings)

<sup>3</sup>[wiki.teltonika-gps.com/view/FMC003\\_Sleep\\_modes#Deep\\_Sleep\\_mode](http://wiki.teltonika-gps.com/view/FMC003_Sleep_modes#Deep_Sleep_mode)

<sup>4</sup>[wiki.teltonika-gps.com/view/FOTA\\_WEB](http://wiki.teltonika-gps.com/view/FOTA_WEB)

<sup>5</sup>[wiki.teltonika-gps.com/view/FOTA](http://wiki.teltonika-gps.com/view/FOTA)

<sup>6</sup>[wiki.teltonika-gps.com/view/Teltonika\\_Configurator](http://wiki.teltonika-gps.com/view/Teltonika_Configurator)

<sup>7</sup>[wiki.teltonika-gps.com/view/FMBT\\_Mobile\\_application](http://wiki.teltonika-gps.com/view/FMBT_Mobile_application)

# SAFETY INFORMATION

This message contains information on how to operate FMC003 safely. By following these requirements and recommendations, you will avoid dangerous situations. You must read these instructions carefully and follow them strictly before operating the device!

- The device uses SELV limited power source. The nominal voltage is +12 V DC. The allowed voltage range is +10...+30 V DC.
- To avoid mechanical damage, it is advised to transport the device in an impact-proof package. Before usage, the device should be placed so that its LED indicators are visible. They show the status of device operation.
- Before unmounting the device from vehicle, ignition **MUST be OFF**.



Do not disassemble the device. If the device is damaged, the power supply cables are not isolated or the isolation is damaged, **DO NOT** touch the device before unplugging the power supply.



All wireless data transferring devices produce interference that may affect other devices which are placed nearby.



Please consult representatives of your vehicle model regarding OBDII location on your vehicle. In case you are not sure about proper connection, please consult qualified personnel.



The programming must be performed using a PC with autonomic power supply.



Installation and/or handling during a lightning storm is prohibited.



The device is susceptible to water and humidity.



Teltonika is not responsible for any harm caused by wrong cables used for connection between PC and FMC003



**WARNING!** Do not use FMC003 device if it distracts driver or causes inconvenience due to OBDII placement. Device must not interfere with driver.



Battery should not be disposed of with general household waste. Bring damaged or worn-out batteries to your local recycling center or dispose them to battery recycle bin found in stores.



# CERTIFICATION AND APPROVALS



This sign on the package means that it is necessary to read the User's Manual before your start using the device. Full User's Manual version can be found in our [Wiki](#)<sup>1</sup>.

<sup>1</sup> [wiki.teltonika-gps.com/index.php?title=FMC003](http://wiki.teltonika-gps.com/index.php?title=FMC003)



The **RoHS**<sup>1</sup> is a directive regulating the manufacture, import and distribution of Electronics and Electrical Equipment (EEE) within the EU, which bans from use 10 different hazardous materials (to date).

<sup>1</sup> [wiki.teltonika-gps.com/view/FMC003\\_RoHS](http://wiki.teltonika-gps.com/view/FMC003_RoHS)

## CHECK ALL CERTIFICATES

All newest certificates may be found in our [Wiki](#)<sup>2</sup>.

<sup>2</sup> [wiki.teltonika-gps.com/view/FMC003\\_Certification\\_%26\\_Approvals](http://wiki.teltonika-gps.com/view/FMC003_Certification_%26_Approvals)



This sign on the package means that all used electronic and electric equipment should not be mixed with general household waste.



Para maiores informações, consulte o site da ANATEL [www.anatel.gov.br](http://www.anatel.gov.br)  
Este equipamento não tem direito à proteção contra interferência prejudicial e não pode causar interferência em sistemas devidamente autorizados.

For more information, see the ANATEL website [www.anatel.gov.br](http://www.anatel.gov.br)

This equipment is not entitled to protection against harmful interference and must not cause interference in duly authorized systems.

# WARRANTY

TELTONIKA guarantees its products to be free of any manufacturing defects for a period of 24 months. With additional agreement we can agree on a different warranty period, for more detailed information please contact our sales manager.

Contact us [teltonika-gps.com/about-us/contacts](https://teltonika-gps.com/about-us/contacts)

All batteries carry a reduced 6 month warranty period.

If a product should fail within this specific warranty time, the product can be:

- Repaired
- Replaced with a new product
- Replaced with an equivalent repaired product fulfilling the same functionality
- TELTONIKA can also repair products that are out of warranty at an agreed cost.

# WARRANTY DISCLAIMER

TELTONIKA PRODUCTS ARE INTENDED TO BE USED BY PERSONS WITH TRAINING AND EXPERIENCE. ANY OTHER USE RENDERS THE LIMITED WARRANTIES EXPRESSED HEREIN AND ALL IMPLIED WARRANTIES NULL AND VOID AND SAME ARE HEREBY EXCLUDED. ALSO EXCLUDED FROM THIS LIMITED WARRANTY ARE ANY AND ALL INCIDENTAL OR CONSEQUENTIAL DAMAGES INCLUDING BUT NOT LIMITED TO, LOSS OF USE OR REVENUE, LOSS OF TIME, INCONVENIENCE OR ANY OTHER ECONOMIC LOSS.

More information can be found at [teltonika-gps.com/warranty-repair](https://teltonika-gps.com/warranty-repair)