



FMC13A

ADVANCED LTE TERMINAL WITH
FLEXIBLE INPUTS CONFIGURATION

Quick Manual v1.5

CONTENT

Content.....	2
Know your device.....	3
Pinout.....	4
Wiring scheme.....	5
Set up your device	6
PC Connection (Windows).....	7
How to install USB drivers (Windows).....	7
Configuration.....	8
Quick SMS configuration.....	10
Mounting recommendations.....	12
Basic characteristics	13
LED indications.....	13
Electrical characteristics.....	16
Safety information	18
Certification	19
Warranty	20
Warranty disclaimer	20

KNOW YOUR DEVICE

TOP VIEW

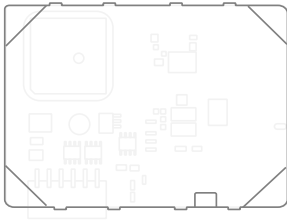

BOTTOM VIEW
(WITHOUT COVER)

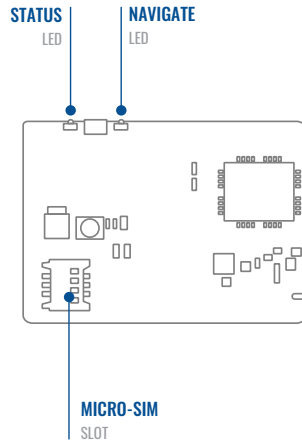

TOP VIEW
(WITHOUT COVER)

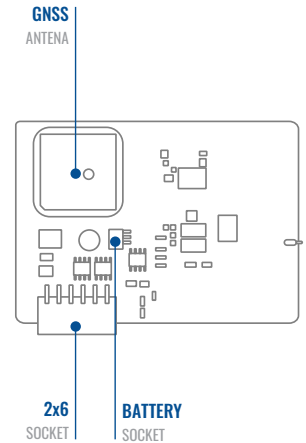

PINOUT

Pin number	Pin name	Description
1	VCC (10-30) V DC (+)	Power supply (10-30 V DC)
2	DOUT 3	Digital output, channel 3. Open collector output. Max. 0,5 A DC
3	DIN 3 / AIN 2	Analog input, channel 2. Input range: 0-30 V DC / Digital input, channel 3
4	DIN 2-N / AIN 1	Digital input, channel 2, Negative input (ground sense), Analog input, channel 1, Input range: 0-30 VDC
5	DIN 1	Digital input, channel 1
6	INPUT 6	TX EXT (LVCAN - TX)
7	GND (-)	Ground pin. (10-30) V DC (-)
8	DOUT 1	Digital output, channel 1. Open collector output. Max. 0,5 A DC



FMC13A 2x6 socket pinout

9	DOUT 2	Digital output, channel 2. Open collector output. Max. 0,5 A DC
10	1WIRE POWER	+3,8 V output for 1-Wire devices
11	1WIRE DATA	Data for 1-Wire devices
12	INPUT 5V	RX EXT (LVCAN - RX)

WIRING SCHEME

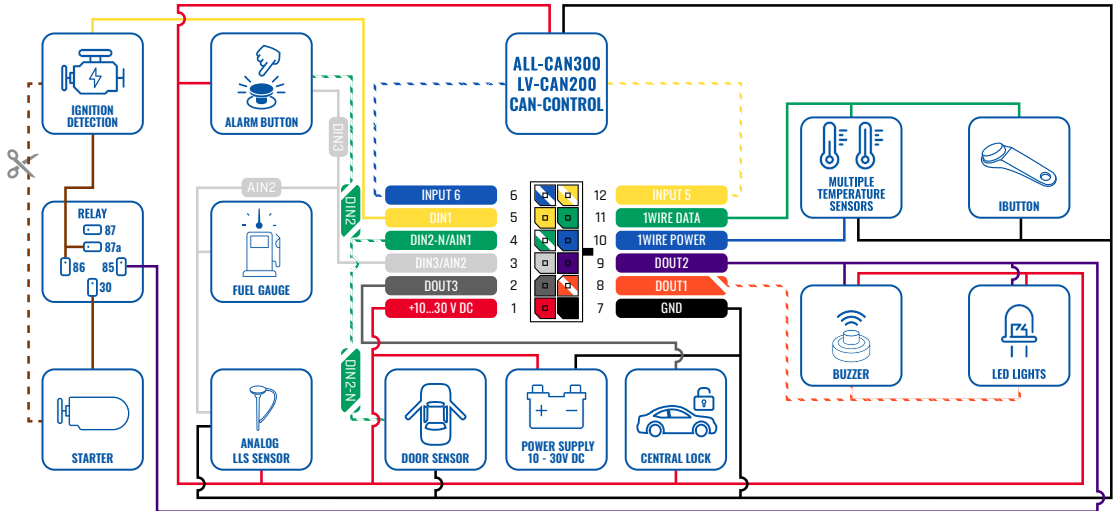

SET UP YOUR DEVICE

HOW TO INSERT MICRO-SIM CARD AND CONNECT THE BATTERY

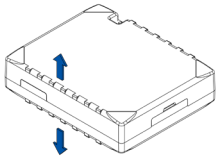

1 COVER REMOVAL

You will receive your device partly closed. Gently remove **top and bottom covers**.

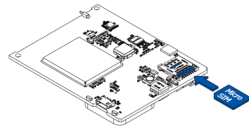

2 MICRO-SIM CARD INSERT

Insert **SIM card** as shown with **PIN request disabled** or read our [Wiki](#)¹ how to enter it later in [Teltonika Configurator](#)². Make sure that Micro-SIM card **cut-off corner** is pointing outward from slot. **SIM slot 1** is closer to PCB, **SIM slot 2** is the top one.

¹ wiki.teltonika-gps.com/view/FMC13A_Security_info

² wiki.teltonika-gps.com/view/Teltonika_Configurator

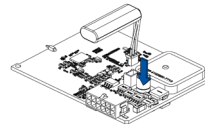

3 BATTERY CONNECTION

Connect **battery** as shown to device. Position the battery in place where it does not obstruct other components.

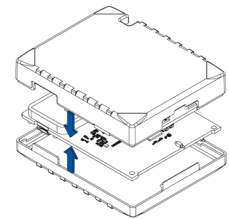

4 ATTACHING COVER BACK

After **configuration**, see "PC Connection (Windows)", attach device **top and bottom cover** back and press them twice to the full closure. Make sure that product casing is closed correctly.

PC CONNECTION (WINDOWS)

1. Power-up FMC13A with **DC voltage (10 – 30 V)** power supply using **supplied power cable**. LED's should start blinking, see "**LED indications**".
2. Connect device to computer using **Micro-USB cable** or Bluetooth connection:
 - Using Micro-USB cable
 - You will need to install USB drivers, see "**How to install USB drivers (Windows)**"
 - Using **Bluetooth**
 - FMC13A **Bluetooth** is enabled by default. Turn on Bluetooth on your PC, then select **Add Bluetooth or other device > Bluetooth**. Choose your device named – "**FMC13A_last_7_imei_digits**", without LE in the end. Enter default password **5555**, press **Connect** and then select **Done**.
3. You are now ready to use the device on your computer.

HOW TO INSTALL USB DRIVERS (WINDOWS)

1. Please download COM port drivers from [here](#).
2. Extract and run **TeltonikaCOMDriver.exe**.
3. Click **Next** in driver installation window.
4. In the following window click **Install** button.
5. Setup will continue installing the driver and eventually the confirmation window will appear. Click **Finish** to complete the setup.

CONFIGURATION

At first FMC13A device will have default factory settings set. These settings should be changed according to the users needs. Main configuration can be performed via [Teltonika Configurator](#)¹ software. Get the latest **Configurator** version from [here](#)². Configurator operates on **Microsoft Windows OS** and uses prerequisite **MS .NET Framework**. Make sure you have the correct version installed.

¹ wiki.teltonika-gps.com/view/Teltonika_Configurator

² wiki.teltonika-gps.com/view/Teltonika_Configurator_versions

MS .Net requirements

Operating system	MS .NET Framework version	Version	Links
Windows Vista			
Windows 7			
Windows 8.1	MS .NET Framework 4.6.2	32 and 64 bit	www.microsoft.com ¹
Windows 10			

¹ <https://dotnet.microsoft.com/en-us/download/dotnet-framework/net462>

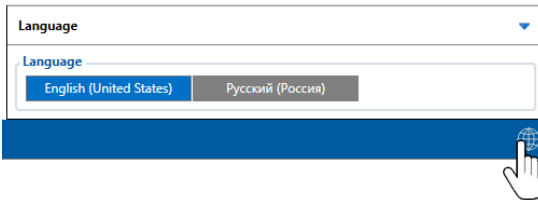

Downloaded Configurator will be in compressed archive. Extract it and launch Configurator.exe. After launch software language can be changed by clicking  in the right bottom corner.

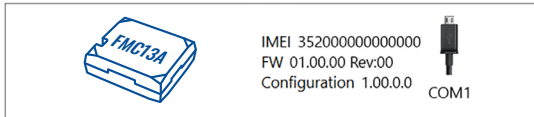



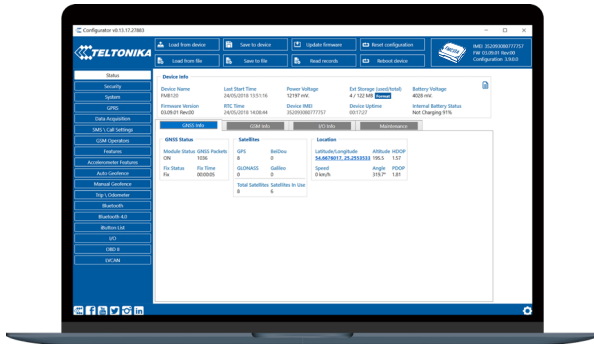





Configuration process begins by pressing on connected device.



After connection to Configurator **Status window** will be displayed.

Various **Status window**¹ tabs display information about **GNSS**², **GSM**³, **I/O**⁴, **Maintenance**⁵ and etc. FMC13A has one user editable profile, which can be loaded and saved to the device. After any modification of configuration the changes need to be saved to device using **Save to device** button. Main buttons offer following functionality:

-  **Load from device** – loads configuration from device.
-  **Save to device** – saves configuration to device.
-  **Load from file** – loads configuration from file.
-  **Save to file** – saves configuration to file.
-  **Update firmware** – updates firmware on device.
-  **Read records** – reads records from the device.
-  **Reboot device** – restarts device.
-  **Reset configuration** – sets device configuration to default.

Most important configurator section is **GPRS** – where all your server and **GPRS settings**⁶ can be configured and **Data Acquisition**⁷ – where data acquiring parameters can be configured. More details about FMC13A configuration using Configurator can be found in our **Wiki**⁸.

¹ wiki.teltonika-gps.com/view/FMC13A_Status_info

² wiki.teltonika-gps.com/view/FMC13A_Status_info#GNSS_Info

³ wiki.teltonika-gps.com/view/FMC13A_Status_info#GSM_Info

⁴ wiki.teltonika-gps.com/view/FMC13A_Status_info#I.2FO_Info

⁵ wiki.teltonika-gps.com/view/FMC13A_Status_info#Maintenance

⁶ wiki.teltonika-gps.com/view/FMC13A_GPRS_settings

⁷ wiki.teltonika-gps.com/view/FMC13A_Data_acquisition_settings

⁸ wiki.teltonika-gps.com/view/FMC13A_Configuration

QUICK SMS CONFIGURATION

Default configuration has optimal parameters present to ensure best performance of track quality and data usage.

Quickly set up your device by sending this SMS command to it:

```
« setparam 2001:APN;2002:APN_username;2003:APN_password;2004:Domain;2005:Port;2006:0»
```

1

2

3

4

5

6

Note: Before SMS text, two space symbols should be inserted.

GPRS SETTINGS:

- 1 2001 – APN
- 2 2002 – APN username (if there are no APN username, empty field should be left)
- 3 2003 – APN password (if there are no APN password, empty field should be left)

SERVER SETTINGS:

- 4 2004 – Domain
- 5 2005 – Port
- 6 2006 – Data sending protocol (0 – TCP, 1 – UDP)

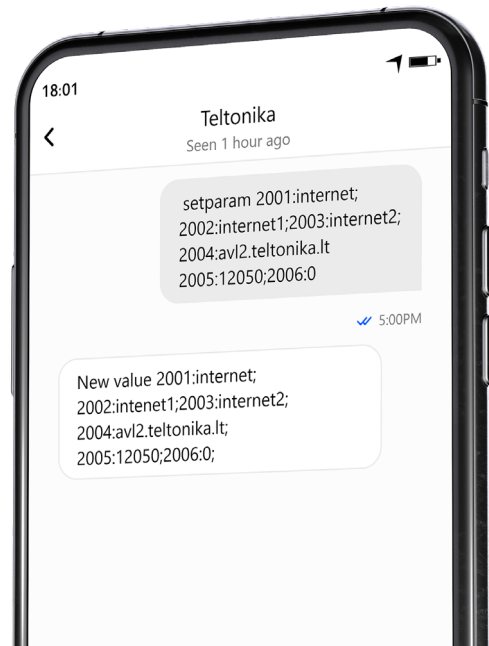

DEFAULT CONFIGURATION SETTINGS

MOVEMENT AND IGNITION DETECTION:



VEHICLE MOVEMENT
will be detected by accelerometer



IGNITION WILL BE DETECTED
by vehicle power voltage
between 13,2 – 30 V

DEVICE MAKES A RECORD ON MOVING IF ONE OF THESE EVENTS HAPPEN:



300 s
300
seconds passes



VEHICLE DRIVES
100 meters



VEHICLE TURNS
10 degrees



SPEED DIFFERENCE
between last coordinate and current
position is greater than 10 km/h

DEVICE MAKES A RECORD ON STOP IF:



1 h
1 HOUR PASSES
while vehicle is stationary and ignition
is off



RECORDS SENDING TO SERVER:

IF DEVICE HAS MADE A RECORD
it is sent to the server every 120 seconds

After successful SMS configuration, FMC13A device will synchronize time and update records to configured server. Time intervals and default I/O elements can be changed by using [Teltonika Configurator¹](#) or [SMS parameters²](#).

¹ wiki.teltonika-gps.com/view/Teltonika_Configurator

² wiki.teltonika-gps.com/view/Template:FMB_Device_Family_Parameter_list

MOUNTING RECOMMENDATIONS

CONNECTING WIRES

- Wires should be connected while the module is not plugged in.
- Wires should be fastened to stable wires or other non-moving parts. Any heat emitting and/or moving objects should be kept away from the wires.
- There should be no exposed wires. If factory isolation was removed while connecting the wires, the isolation material should be applied.
- If the wires are placed in the exterior or in places where they can be damaged or exposed to heat, humidity, dirt, etc., additional isolation should be applied and the wires should not be loose.
- Wires cannot be connected to the board computers or control units.

CONNECTING POWER SOURCE

- Be sure that after the car computer goes to sleep mode, power might be still available on the power wires. Depending on the car model, this may happen in 5 to 30 minutes period.
- When the module is connected, measure the voltage again to make sure it did not decrease.
- It is recommended to connect to the main power cable in the fuse box.
- 3 A, 125 V external fuse shall be used.

CONNECTING IGNITION WIRE

- Be sure to check if it is a real ignition wire i. e. power does not disappear after starting the engine.
- Check if this is not an ACC wire (when key is in the first position, most of the vehicle electronics are available).
- Check if power is still available when you turn off any of vehicles devices.
- Ignition is connected to the ignition relay output. As alternative, any other relay, which has power output when ignition is on, may be chosen.

CONNECTING GROUND WIRE

- Ground wire is connected to the vehicle frame or metal parts that are fixed to the frame.
- If the wire is fixed with the bolt, the loop must be connected to the end of the wire.
- For better contact scrub paint from the spot where loop is going to be connected.

LED INDICATIONS

NAVIGATION LED INDICATIONS

Behaviour	Meaning
Permanently switched on	GNSS signal is not received
Blinking every second	Normal mode, GNSS is working
Off	GNSS is turned off because: Device is not working or Device is in sleep mode
Blinking fast constantly	Device firmware is being flashed

STATUS LED INDICATIONS

Behaviour	Meaning
Blinking every second	Normal mode
Blinking every two seconds	Sleep mode
Blinking fast for a short time	Modem activity
Off	Device is not working or Device is in boot mode

BASIC CHARACTERISTICS

Module

Name	FMC13A-QBIB0: Quectel EG91-NA with Teltonika TM2500
Technology	LTE(CAT1)/UMTS/GNSS/BLUETOOTH

GNSS

GNSS	GPS, GLONASS, GALILEO, BEIDOU, QZSS, AGPS
Receiver	33 channel
Tracking sensitivity	-165 dBm
Position Accuracy	< 2.5 CEP
Velocity Accuracy	< 0.1 m/s (within +/- 15% error)
Hot start	< 1 s
Warm start	< 25 s
Cold start	< 35 s

Celluar

Technology	LTE Cat 1, UMTS
3G bands	WCDMA: B2/B4/B5
4G bands	LTE FDD: B2/B4/B5/B12/B13

Data transfer	LTE: LTE FDD: Max 10Mbps (DL)/Max 5Mbps (UL) UMTS: WCDMA: Max 384Kbps (DL)/Max 384 Kbps (UL)
---------------	---

Transmit power	Class 4 for GSM850/900 23±2dBm Class 1 for GSM1800/1900 20±2dBm Class 3 for LTE-TDD: 23±2.7dBm Class 3 for LTE-FDD: 23±2.7dBm
----------------	--

Data support	SMS (text/data)
--------------	-----------------

Power

Input voltage range	10 - 30 V DC with overvoltage protection
---------------------	--

Internal Back-up battery	170 mAh Li-Po battery 3.7 V (0.63 Wh)
--------------------------	---------------------------------------

Internal fuse	3 A, 125 V
---------------	------------

Power Consumption	At 12V < 3 mA (Ultra Deep Sleep)
	At 12V < 5 mA (Deep Sleep)
	At 12V < 16 mA (Online Deep Sleep)
	At 12V < 18 mA (GPS Sleep)
	At 12V < 33 mA (nominal with no load)
	At 12V < 2A Max. (with full Load / Peak)

Bluetooth

Specification	4.0 + LE
---------------	----------

Supported peripherals	Temperature and Humidity sensor, OBDI dongle, Inateck Barcode Scanner, Universal BLE sensors support
-----------------------	--

Interface

Connection	3
------------	---

Negative Inputs	1 (Digital Input 2)
-----------------	---------------------

Impulse Inputs	2 (Digital Input 1, Digital Input 2)
----------------	--------------------------------------

Digital Outputs	3
-----------------	---

Analog Inputs	2
---------------	---

CAN Adapter inputs	1
--------------------	---

1-Wire	1
--------	---

GNSS antenna	Internal High Gain
--------------	--------------------

Cellular antenna	Internal High Gain
------------------	--------------------

USB	2.0 Micro-USB
-----	---------------

LED indication	2 status LED lights
----------------	---------------------

SIM	Micro-SIM + eSIM
-----	------------------

Memory	128MB internal flash memory
--------	-----------------------------

Physical specification

Dimensions	77 x 62 x 20 mm (L x W x H)
------------	-----------------------------

Operating Environment

Operating temperature (without battery)	-20 °C to +85°C
Storage temperature (without battery)	-20 °C to +85°C
Operating temperature (with battery)	-20 °C to +40 °C
Storage temperature (with battery)	-20 °C to +45 °C for 1 month -20 °C to +35 °C for 6 months
Operating humidity	5% to 95% non-condensing
Ingress Protection Rating	IP67
Battery charge temperature	0 °C to +45 °C
Battery discharge temperature	-20 °C to +60 °C
Battery storage temperature	-20 °C to +45 °C for 1 month -20 °C to +35 °C for 6 months

Features

Sensors	Accelerometer
---------	---------------

Scenarios	Green Driving, Over Speeding detection, GNSS Fuel Counter, DOUT Control Via Call, Excessive Idling detection, Immobilizer, iButton Read Notification, Unplug detection, Towing detection, Crash detection, Auto Geofence, Manual Geofence, Trip, Ground Sense
Sleep modes	GPS Sleep, Online Deep Sleep, Deep Sleep, Ultra Deep Sleep
Configuration and firmware update	FOTA Web, FOTA, Teltonika Configurator (USB, Bluetooth), FMBT mobile application (Configuration)
SMS	Configuration, Events, DOUT control, Debug
GPRS commands	Configuration, DOUT control, Debug
Time Synchronization	GPS, NITZ, NTP
Fuel monitoring	LLS (Analog), LV-CAN200, ALL-CAN300, OBDII dongle, CAN-CONTROL
Ignition detection	Digital Input 1, Accelerometer, External Power Voltage, Engine RPM (CAN Adapters, OBDII dongle)

ELECTRICAL CHARACTERISTICS

Characteristic description	Value			
	Min.	Typ.	Max.	Unit
Supply voltage (Recommended Operating Conditions)	+10		+30	V

Digital output (open drain grade)

Drain current (Digital Output OFF)			120	μA
Drain current (Digital Output ON, Recommended Operating Conditions)	0.1	0.5		A
Static Drain-Source resistance (Digital Output ON)	400	600		mΩ

Digital input

Input resistance (DIN1)	47			kΩ
Input resistance (DIN2)	38.45			kΩ
Input resistance (DIN3)	150			kΩ

Input voltage (Recommended Operating Conditions)	0	Supply voltage	V
Input Voltage threshold (DIN1)	7.5		V
Input Voltage threshold (DIN2)	2.5		V
Input Voltage threshold (DIN3)	2.5		V

Analog input

Input voltage (Recommended Operating Conditions), Range 1	0		V
Input resistance, Range 1	38.45		kΩ
Measurement error on 12V, Range 1	0.9		%
Additional error on 12 V, Range 1	108		mV
Measurement error on 30 V, Range 1	0.33		%
Additional error on 30 V, Range 1	88		mV
Input Voltage (Recommended Operating Conditions), Range 2	0		V

Input resistance, Range 2	150	k Ω
Measurement error on 12 V, Range 2	0.9	%
Additional error on 12 V, Range 2	108	mV
Measurement error on 30 V, Range 2	0.33	%
Additional error on 30 V, Range 2	88	mV

Output supply voltage 1-wire

Supply voltage	+4.5	+4.7	V
Output inner resistance	7		Ω
Output current ($U_{out} > 3.0$ V)	30		mA
Short circuit current ($U_{out} = 0$)	75		mA

Negative input

Input resistance	38.45		k Ω
Input voltage (Recommended Operating Conditions)	0	Supply voltage	V
Input voltage threshold	0.5		V
Sink current		180	nA

SAFETY INFORMATION

- This message contains information on how to operate FMC13A safely. By following these requirements and recommendations, you will avoid dangerous situations. You must read these instructions carefully and follow them strictly before operating the device!
- The device uses SELV limited power source. The nominal voltage is +12 V DC. The allowed voltage range is +10..+30 V DC.
- To avoid mechanical damage, it is advised to transport the device in an impact-proof package. Before usage, the device should be placed so that its LED indicators are visible. They show the status of device operation.
- When connecting the 2x6 connector wires to the vehicle, the appropriate jumpers of the vehicle power supply should be disconnected.
- Before unmounting the device from the vehicle, the 2x6 connector must be disconnected. The device is designed to be mounted in a zone of limited access, which is inaccessible to the operator. All related devices must meet the requirements of EN 60950-1 standard.
- The device FMC13A is not designed as a navigational device for boats.
- Before unmounting the device from vehicle, ignition **MUST be OFF**.



Do not disassemble the device. If the device is damaged, the power supply cables are not isolated or the isolation is damaged, DO NOT touch the device before unplugging the power supply.



All wireless data transferring devices produce interference that may affect other devices which are placed nearby.



The device must be connected only by qualified personnel.



The device must be firmly fastened in a predefined location.



The programming must be performed using a PC with autonomic power supply.



Installation and/or handling during a lightning storm is prohibited.



The device is susceptible to water and humidity.



CAUTION: Risk of explosion if battery is replaced by an incorrect type. Dispose of used batteries according to the instructions.



Battery should not be disposed of with general household waste. Bring damaged or worn-out batteries to your local recycling center or dispose them to battery recycle bin found in stores.

CERTIFICATION



This sign on the package means that it is necessary to read the User 's Manual before your start using the device. Full User 's Manual version can be found in our [Wiki](#)¹.



This sign on the package means that all used electronic and electric equipment should not be mixed with general household waste.

¹ https://wiki.teltonika.lt/view/FMC13A_RoHS

CHECK ALL CERTIFICATES

All newest certificates may be found in our [Wiki](#)².

² wiki.teltonika-gps.com/view/FMC13A_Certification_%26_Approvals

WARRANTY

TELTONIKA guarantees its products to be free of any manufacturing defects for a period of **24 months**. With additional agreement we can agree on a different warranty period, for more detailed information please contact our sales manager.

Contact us teltonika-iot-group.com/about-us/contacts/

All batteries carry a reduced 6 month warranty period.

If a product should fail within this specific warranty time, the product can be:

- Repaired
- Replaced with a new product
- Replaced with an equivalent repaired product fulfilling the same functionality
- TELTONIKA can also repair products that are out of warranty at an agreed cost.

WARRANTY DISCLAIMER

TELTONIKA PRODUCTS ARE INTENDED TO BE USED BY PERSONS WITH TRAINING AND EXPERIENCE. ANY OTHER USE RENDERS THE LIMITED WARRANTIES EXPRESSED HEREIN AND ALL IMPLIED WARRANTIES NULL AND VOID AND SAME ARE HEREBY EXCLUDED. ALSO EXCLUDED FROM THIS LIMITED WARRANTY ARE ANY AND ALL INCIDENTAL OR CONSEQUENTIAL DAMAGES INCLUDING BUT NOT LIMITED TO, LOSS OF USE OR REVENUE, LOSS OF TIME, INCONVENIENCE OR ANY OTHER ECONOMIC LOSS.

More information can be found at teltonika-iot-group.com/about-us/policies-certificates/warranty-repair