



FMB930

Small and smart tracker

Quick Manual v1.4

CONTENT

Know your device.....	3
Pinout	4
Wiring scheme.....	5
Set up your device	6
PC Connection (Windows).....	7
How to install USB drivers (Windows)	7
Configuration.....	8
Quick SMS configuration.....	10
Mounting recommendations.....	12
Basic characteristics	13
LED indications.....	13
Electrical characteristics.....	16
Safety information	17
Certification and Approvals	18
Warranty	19
Warranty disclaimer	19

KNOW YOUR DEVICE

TOP VIEW

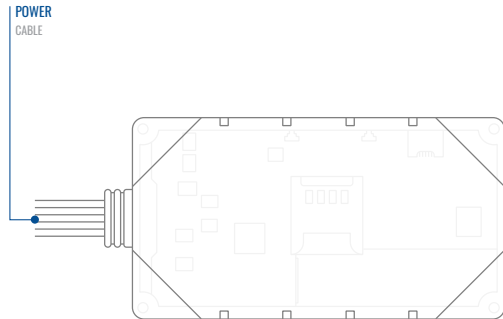

BOTTOM VIEW (WITHOUT COVER)

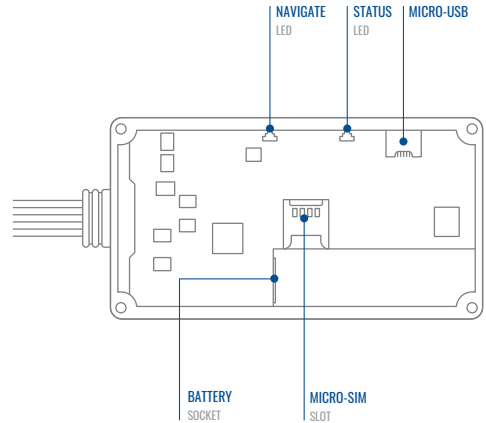

PINOUT

PIN NUMBER	PIN NAME	DESCRIPTION
1	VCC (10-90) V DC (+)	(Red) Power supply (+10-90 V DC)
2	GND (-)	(Black) Ground
3	DIN1	(Yellow) Digital input, channel 1. DEDICATED FOR IGNITION INPUT
4	DOUT2	(Grey) Digital output. Open collector output. Max. 0,5 A DC
5	DOUT1	(White) Digital output. Open collector output. Max. 0,5 A DC

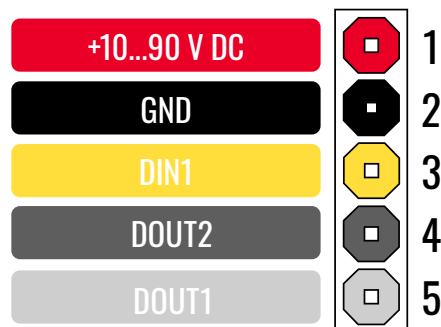

FMB930 pinout

WIRING SCHEME

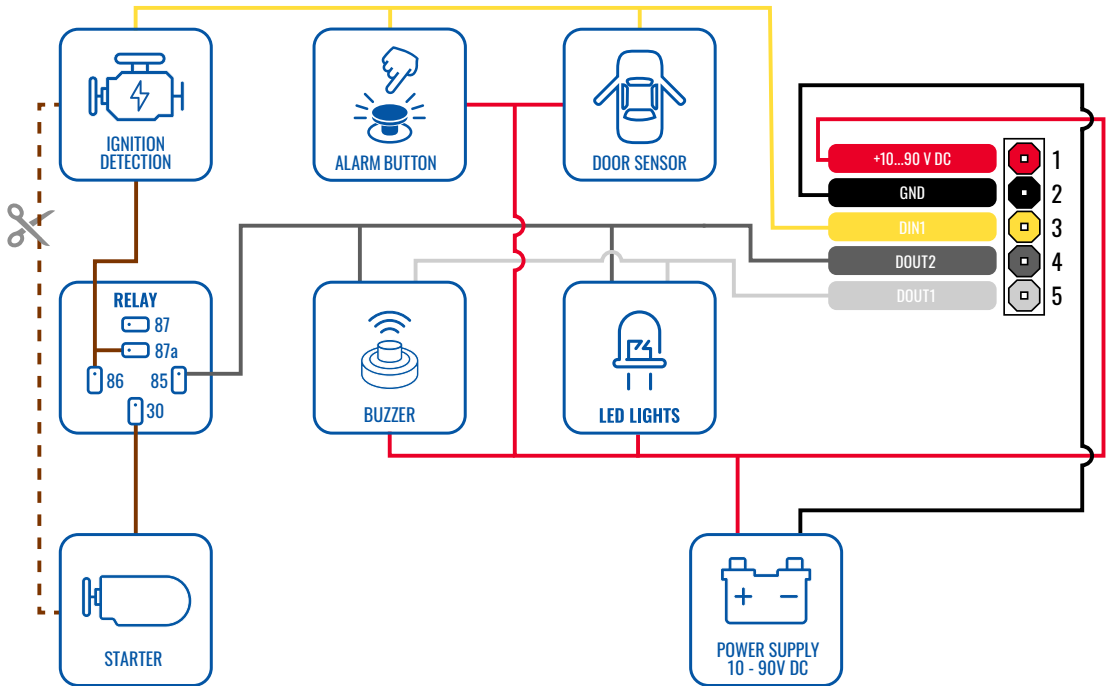

SET UP YOUR DEVICE

HOW TO INSERT MICRO-SIM CARD

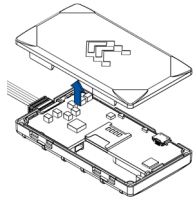

1 COVER REMOVAL

Gently remove FMB930 cover using plastic pry tool from both sides.

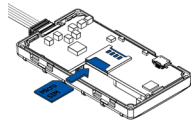

2 MICRO-SIM CARD INSERT

Insert Micro-SIM card as shown with PIN request disabled or read our [Wiki](#)¹ how to enter it later in [Teltonika Configurator](#)². Make sure that Micro-SIM card cut-off corner is pointing forward to slot.

¹wiki.teltonika-gps.com/view/FMB930_Security_info

²wiki.teltonika-gps.com/view/Teltonika_Configurator

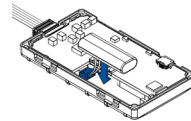

3 BATTERY CONNECTION

Connect the battery as shown on device. Position the battery in place where it does not obstruct other components.

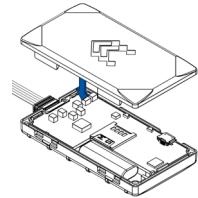

4 ATTACHING COVER BACK

After configuration, see [PC Connection \(Windows\)](#)³, attach device cover back.

³Page 7, "PC Connection (Windows)"

PC CONNECTION (WINDOWS)

1. Power-up FMB930 with **DC voltage (10 – 90 V)** power supply using power wires. LED's should start blinking, see "**LED indications**".
2. Connect device to computer using **Micro-USB** cable or **Bluetooth** connection:
 - Using **Micro-USB cable**
 - You will need to install USB drivers, see "**How to install USB drivers (Windows)**"¹
 - Using **Bluetooth**
 - FMB930 Bluetooth is enabled by default. Turn on **Bluetooth** on your PC, then select **Add Bluetooth or other device > Bluetooth**. Choose your device named – "**FMB930_last_7_imei_digits**", without LE in the end.
 - Enter default password **5555**, press **Connect** and then select **Done**.
3. You are now ready to use the device on your computer.

¹Page 13, "LED indications"

²Page 7, "How to install USB drivers (Windows)"

HOW TO INSTALL USB DRIVERS (WINDOWS)

1. Please download COM port drivers from [here](#)¹.
2. Extract and run **TeltonikaCOMDriver.exe**.
3. Click **Next** in driver installation window.
4. In the following window click **Install** button.
5. Setup will continue installing the driver and eventually the confirmation window will appear. Click **Finish** to complete the setup.

¹teltonika-gps.com/downloads/en/FMB930/TeltonikaCOMDriver.zip

CONFIGURATION

At first FMB930 device will have default factory settings set. These settings should be changed according to the users needs. Main configuration can be performed via [Teltonika Configurator](#)¹ software. Get the latest **Configurator** version from [here](#)². Configurator operates on **Microsoft Windows OS** and uses prerequisite **MS .NET Framework**. Make sure you have the correct version installed.

¹ wiki.teltonika-gps.com/view/Teltonika_Configurator

² wiki.teltonika-gps.com/view/Teltonika_Configurator_versions

MS .NET REQUIREMENTS

Operating system	MS .NET Framework version	Version	Links
Windows Vista			
Windows 7			
Windows 8.1	MS .NET 5.0	32 and 64 bit	www.microsoft.com ¹
Windows 10			

¹ dotnet.microsoft.com/en-us/download/dotnet/5.0/runtime

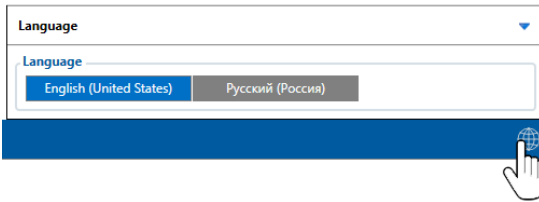

Downloaded Configurator will be in compressed archive. Extract it and launch Configurator.exe. After launch software language can be changed by clicking  in the right bottom corner.

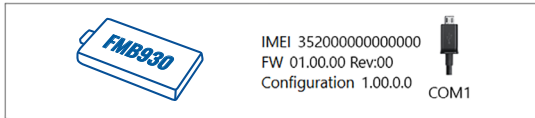



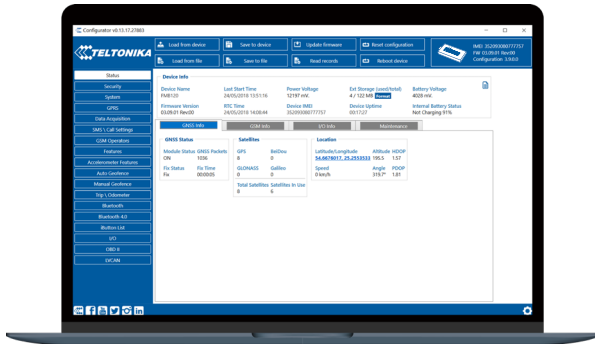





Configuration process begins by pressing on connected device.



After connection to Configurator **Status window** will be displayed.

Various **Status window**¹ tabs display information about **GNSS**², **GSM**³, **I/O**⁴, **Maintenance**⁵ and etc. FMB930 has one user editable profile, which can be loaded and saved to the device. After any modification of configuration the changes need to be saved to device using **Save to device** button. Main buttons offer following functionality:

-  **Load from device** – loads configuration from device.
-  **Save to device** – saves configuration to device.
-  **Load from file** – loads configuration from file.
-  **Save to file** – saves configuration to file.
-  **Update firmware** – updates firmware on device.
-  **Read records** – reads records from the device.
-  **Reboot device** – restarts device.
-  **Reset configuration** – sets device configuration to default.

Most important configurator section is **GPRS** – where all your server and **GPRS settings**⁶ can be configured and **Data Acquisition**⁷ – where data acquiring parameters can be configured. More details about FMB930 configuration using Configurator can be found in our **Wiki**⁸.

¹ wiki.teltonika-gps.com/view/FMB930_Status_info

² wiki.teltonika-gps.com/view/FMB930_Status_info#GNSS_Info

³ wiki.teltonika-gps.com/view/FMB930_Status_info#GSM_Info

⁴ wiki.teltonika-gps.com/view/FMB930_Status_info#I2FO_Info

⁵ wiki.teltonika-gps.com/view/FMB930_Status_info#Maintenance

⁶ wiki.teltonika-gps.com/view/FMB930_GPRS_settings

⁷ wiki.teltonika-gps.com/view/FMB930_Data_acquisition_settings

⁸ wiki.teltonika-gps.com/view/FMB930_Configuration

QUICK SMS CONFIGURATION

Default configuration has optimal parameters present to ensure best performance of track quality and data usage.

Quickly set up your device by sending this SMS command to it:

```
« setparam 2001:APN;2002:APN_username;2003:APN_password;2004:Domain;2005:Port;2006:0»
```

1

2

3

4

5

6

Note: Before SMS text, two space symbols should be inserted.

GPRS SETTINGS:

- 1 2001 – APN
- 2 2002 – APN username (if there are no APN username, empty field should be left)
- 3 2003 – APN password (if there are no APN password, empty field should be left)

SERVER SETTINGS:

- 4 2004 – Domain
- 5 2005 – Port
- 6 2006 – Data sending protocol (0 – TCP, 1 – UDP)

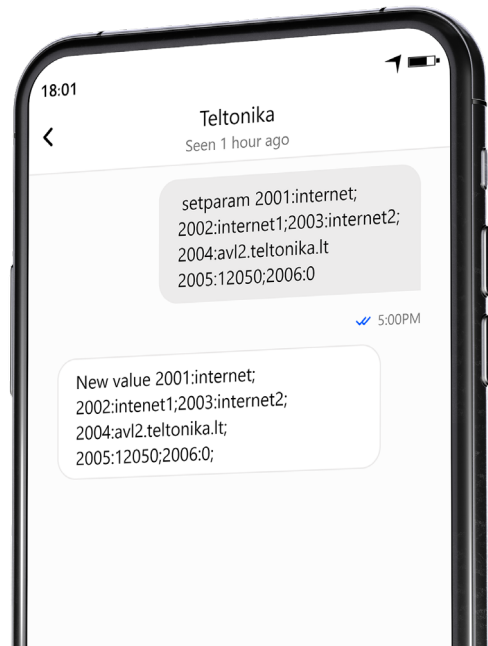

DEFAULT CONFIGURATION SETTINGS

MOVEMENT AND IGNITION DETECTION:



VEHICLE MOVEMENT
will be detected by accelerometer



IGNITION WILL BE DETECTED
by vehicle power voltage
between 13,2 – 30 V

DEVICE MAKES A RECORD ON MOVING IF ONE OF THESE EVENTS HAPPEN:



300 s
300
seconds passes



VEHICLE DRIVES
100 meters



VEHICLE TURNS
10 degrees



SPEED DIFFERENCE
between last coordinate and current
position is greater than 10 km/h

DEVICE MAKES A RECORD ON STOP IF:



1 h
1 HOUR PASSES
while vehicle is stationary and ignition
is off



RECORDS SENDING TO SERVER:

IF DEVICE HAS MADE A RECORD
it is sent to the server every 120 seconds

After successful SMS configuration, FMB930 device will synchronize time and update records to configured server. Time intervals and default I/O elements can be changed by using [Teltonika Configurator¹](#) or [SMS parameters²](#).

¹ wiki.teltonika-gps.com/view/Teltonika_Configurator

² wiki.teltonika-gps.com/view/Template:FMB_Device_Family_Parameter_list

MOUNTING RECOMMENDATIONS

CONNECTING WIRES

- Wires should be fastened to the other wires or non-moving parts. Try to avoid heat emitting and moving objects near the wires.
- The connections should not be seen very clearly. If factory isolation was removed while connecting wires, it should be applied again.
- If the wires are placed in the exterior or in places where they can be damaged or exposed to heat, humidity, dirt, etc., additional isolation should be applied.
- Wires cannot be connected to the board computers or control units.

CONNECTING POWER SOURCE

- Be sure that after the car computer falls asleep, power is still available on chosen wire. Depending on car, this may happen in 5 to 30 minutes period.
- When module is connected, measure voltage again to make sure it did not decrease.
- It is recommended to connect to the main power cable in the fuse box.
- Use 3A, 125V external fuse.

CONNECTING IGNITION WIRE

- Be sure to check if it is a real ignition wire i. e. power does not disappear after starting the engine.
- Check if this is not an ACC wire (when key is in the first position, most of the vehicle electronics are available).
- Check if power is still available when you turn off any of vehicles devices.
- Ignition is connected to the ignition relay output. As alternative, any other relay, which has power output when ignition is on, may be chosen.

CONNECTING GROUND WIRE

- Ground wire is connected to the vehicle frame or metal parts that are fixed to the frame.
- If the wire is fixed with the bolt, the loop must be connected to the end of the wire.
- For better contact scrub paint from the spot where loop is going to be connected.

LED INDICATIONS

NAVIGATION LED INDICATIONS

BEHAVIOUR	MEANING
Permanently switched on	GNSS signal is not received
Blinking every second	Normal mode, GNSS is working
Off	GNSS is turned off because: Device is not working or Device is in sleep mode
Blinking fast constantly	Device firmware is being flashed

STATUS LED INDICATIONS

BEHAVIOUR	MEANING
Blinking every second	Normal mode
Blinking every two seconds	Sleep mode
Blinking fast for a short time	Modem activity
Off	Device is not working or Device is in boot mode

BASIC CHARACTERISTICS

MODULE

Name	FMB930-TAIB0: Teltonika TM2500
Technology	GSM/GPRS/GNSS/BLUETOOTH

GNSS

GNSS	GPS, GLONASS, GALILEO, BEIDOU, QZSS, AGPS
Receiver	33 channel
Tracking sensitivity	-165 dBm
Accuracy	< 3 m
Hot start	< 1 s
Warm start	< 25 s
Cold start	< 35 s

CELLULAR

Technology	GSM
2G bands	Quad-band 850 / 900 / 1800 / 1900 MHz
Data transfer	GPRS Multi-Slot Class 12 (up to 240 kbps), GPRS Mobile Station Class B
Data support	SMS (text/data)

POWER

Input voltage range	10-90 V DC
Back-up battery	170 mAh Li-Ion battery (0.63Wh)

BLUETOOTH

Specification	4.0 + LE
Supported peripherals	Temperature and Humidity sensor¹, OBDII dongle² , Inateck Barcode Scanner, Universal BLE sensors support

INTERFACE

Digital Inputs	1
Digital Outputs	2
GNSS antenna	Internal High Gain
Cellular antenna	Internal High Gain
USB	2.0 Micro-USB
LED indication	2 status LED lights
SIM	Micro-SIM
Memory	128MB internal flash memory

¹teltonika.lt/product/bluetooth-sensor

²wiki.teltonika.lt/view/How_to_connect_OBD_II_Blue-tooth_Dongle_to_FMB_device

PHYSICAL SPECIFICATION

Dimensions	79 x 43 x 12 mm (L x W x H)
Weight	54 g

OPERATING ENVIRONMENT

Operating temperature (with battery)	-20 °C to +40 °C
Operating temperature (without battery)	-40 °C to +85 °C
Storage temperature (without battery)	-40 °C to +85 °C
Operating humidity	5% to 95% non-condensing
Ingress Protection Rating	IP54
Battery charge temperature	0 °C to +45 °C
Battery discharge temperature	-20 °C to +60 °C
Battery storage temperature	-20 °C to +35 °C for 1 month -20 °C to +35 °C for 6 months

FEATURES

Sensors	Accelerometer
---------	---------------

Scenarios	Green Driving, Over Speeding detection, GNSS Fuel Counter, DOUT Control Via Call , Excessive Idling detection, Unplug detection, Towing detection, Crash detection, Auto Geofence, Manual Geofence, Trip ³
Sleep modes	GPS Sleep, Online Deep Sleep, Deep Sleep, Ultra Deep Sleep⁴, Power Off Sleep⁵
Configuration and firmware update	FOTA Web⁶, FOTA⁷, Teltonika Configurator⁸ (USB, Bluetooth), FMBT mobile application⁹ (Configuration)
SMS	Configuration, Events, DOUT Control, Debug

GPRS commands	Configuration, DOUT control, Debug
Time Synchronization	GPS, NITZ, NTP
Fuel monitoring	OBDI dongle¹⁰
Ignition detection	Digital Input 1, Accelerometer, External Power Voltage, Engine RPM (OBDI dongle¹⁴)

¹⁰wiki.teltonika-gps.com/view/How_to_connect_OBD_II_Bluetooth_Dongle_to_FMB_device

³wiki.teltonika-gps.com/view/FMB930_Features_settings

⁴wiki.teltonika-gps.com/view/FMB930_Sleep_modes

⁵wiki.teltonika-gps.com/view/FMB930_Sleep_modes#Power_off_sleep_mode

⁶wiki.teltonika-gps.com/view/FOTA_WEB

⁷wiki.teltonika-gps.com/view/FOTA

⁸wiki.teltonika-gps.com/view/Teltonika_Configurator

⁹wiki.teltonika-gps.com/view/FMBT_Mobile_application

ELECTRICAL CHARACTERISTICS

CHARACTERISTIC DESCRIPTION	VALUE			
	MIN.	TYP.	MAX.	UNIT
Supply Voltage (Recommended Operating Conditions)	+10		+90	V

DIGITAL OUTPUT (OPEN DRAIN GRADE)

Drain current (Digital Output OFF)			120	μA
Drain current (Digital Output ON, Recommended Operating Conditions)			0.5	A
Static Drain-Source resistance (Digital Output ON)			300	mΩ

DIGITAL INPUT

Input resistance (DIN1)	561			kΩ
Input voltage (Recommended Operating Conditions)	0		90	V
Input Voltage threshold		2.5		V

SAFETY INFORMATION

This message contains information on how to operate FMB930 safely. By following these requirements and recommendations, you will avoid dangerous situations. You must read these instructions carefully and follow them strictly before operating the device!

- The device uses SELV limited power source. The nominal voltage is +12 V DC. The allowed voltage range is +10...+90 V DC.
- To avoid mechanical damage, it is advised to transport the device in an impact-proof package. Before usage, the device should be placed so that its LED indicators are visible. They show the status of device operation.
- When connecting the connection (1x5) cables to the vehicle, the appropriate jumpers of the power supply of the vehicle should be disconnected.
- Before dismantling the device from the vehicle, the 1x5 connection must be disconnected.
- The device is designed to be mounted in a zone of limited access, which is inaccessible to the operator. All related devices must meet the requirements of EN 62368-1 standard.
- The device FMB930 is not designed as a navigational device for boats.



Do not disassemble the device. If the device is damaged, the power supply cables are not isolated or the isolation is damaged, DO NOT touch the device before unplugging the power supply.



All wireless data transferring devices produce interference that may affect other devices which are placed nearby.



The device must be connected only by qualified personnel.



The device must be firmly fastened in a predefined location.



The programming must be performed using a PC with autonomic power supply.



Installation and/or handling during a lightning storm is prohibited.



The device is susceptible to water and humidity.

CERTIFICATION AND APPROVALS



This sign on the package means that it is necessary to read the User's Manual before you start using the device. Full User's Manual version can be found in our [Wiki](#)¹.

¹ wiki.teltonika-gps.com/view/FMB930



This sign on the package means that all used electronic and electric equipment should not be mixed with general household waste.

CHECK ALL CERTIFICATES

All newest certificates may be found in our [Wiki](#)².

² wiki.teltonika-gps.com/view/FMB930_Certification_%26_Approvals

WARRANTY

We guarantee our products 24-month warranty¹ period.

All batteries carry a 6-month warranty period.

Post-warranty repair service for products is not provided.

If a product stops operating within this specific warranty time, the product can be:

- Repaired
- Replaced with a new product
- Replaced with an equivalent repaired product fulfilling the same functionality
- Replaced with a different product fulfilling the same functionality in case of EOL for the original product

¹ Additional agreement for an extended warranty period can be agreed upon separately.

WARRANTY DISCLAIMER

- Customers are only allowed to return products as a result of the product being defective, due to order assembly or manufacturing fault.
- Products are intended to be used by personnel with training and experience.
- Warranty does not cover defects or malfunctions caused by accidents, misuse, abuse, catastrophes, improper maintenance or inadequate installation – not following operating instructions (including failure to heed warnings) or use with equipment with which it is not intended to be used.
- Warranty does not apply to any consequential damages.
- Warranty is not applicable for supplementary product equipment (i. e. PSU, power cables, antennas) unless the accessory is defective on arrival.
- [More information on what is RMA¹](#)

¹ wiki.teltonika-gps.com/view/RMA_guidelines