

FMC920 First Start

[Main Page](#) > [Basic Trackers](#) > [FMC920](#) > **FMC920 First Start**



Small and smart tracker with Bluetooth® and internal backup battery



Contents

- [1 How to insert Micro-SIM card](#)
- [2 Pinout](#)
 - [2.1 Configuration \(Windows\)](#)
- [3 Quick start guide](#)
- [4 Mounting recommendations](#)
- [5 Installation photos](#)
- [6 Safety information](#)
 - [6.1 Precautions](#)

How to insert Micro-SIM card

1. Gently remove FMC920 **cover** using **plastic pry tool** from both sides.
2. Insert **Micro-SIM** card as shown with **PIN request disabled** or read [Security info](#) how to enter it later in Configurator. Make sure that Micro-SIM card **cut-off corner** is pointing forward to slot.
3. Remove the adhesive tape protection.
4. Place the battery inside the casing of the FMC920. Make sure the adhesive tape sticks to the casing.
5. Connect the internal battery to the FMC920 PCB.

6. Attach device **cover** back. Device is ready to be connected.



 **Micro-SIM card insertion/removal must be performed when device is powered off - external voltage and internal battery disconnected. Otherwise Micro-SIM card might be damaged or device will not detect it.**

Pinout

PIN NUMBER	PIN NAME	DESCRIPTION
1	VCC (10-30)V DC (+)	Power supply (10-30) V DC (+).
2	GND (-)	Ground.
3	DIN 1	Digital input, channel 1. DEDICATED FOR IGNITION INPUT
4	AIN 1	Analog input, channel 1. Input range: 0-30 V DC.
5	DOUT 1	Digital output. Open collector output. Max. 3,3 A DC.

Configuration (Windows)

At first FMC920 device will have default factory settings set. These settings should be changed according to the user's needs.

Main configuration can be performed via [Teltonika Configurator](#) software. Get the latest FMC920 **Configurator** version from [here](#). Configurator operates on Microsoft Windows OS and uses prerequisite MS .NET Framework. Make sure you have the correct version installed.

MS .NET requirements

Operating system	MS .NET Framework version	Version	Link
• Windows Vista	MS .NET Framework 5.0	32 and 64 bit	↓ .NET Framework
• Windows 7			
• Windows 8.1			
• Windows 10			

Downloaded **Configurator** will be in compressed archive. Extract it and launch **Configurator.exe**. After launch software language can be changed by clicking  in the right bottom corner:

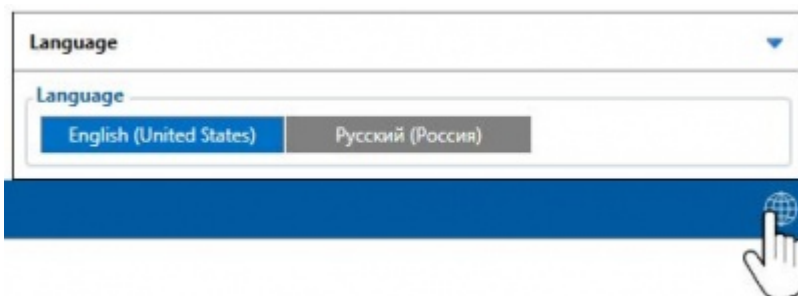









Configuration process begins by pressing on connected device:



After connection to Configurator **Status window** will be displayed:



Various [Status window](#) tabs display information about [GNSS](#), [GSM](#), [I/O](#), [Maintenance](#) and etc. FMC920 has one user editable profile, which can be loaded and saved to the device. After any modification of configuration the changes need to be saved to device using **Save to device** button. Main buttons offer following functionality:

1.  **Load from device** - loads configuration from device.
2.  **Save to device** - saves configuration to device.
3.  **Load from file** - loads configuration from file.
4.  **Save to file** - saves configuration to file.
5.  **Update firmware** - updates firmware on device.
6.  **Read records** - read records from device.
7.  **Reboot device** - restarts device.
8.  **Reset configuration** - sets device configuration to default.

Most important configurator section is GPRS - where all your server and [GPRS settings](#) can be configured and [Data Acquisition](#) - where data acquiring parameters can be configured. More details about FMC920 configuration using Configurator can be found [here](#).

Quick start guide

Mounting recommendations

- Connecting wires
 - Wires should be fastened to stable wires or other non-moving parts. Any heat emitting and/or moving objects should be kept away from the wires.
 - There should be no exposed wires. If factory isolation was removed while connecting wires, the isolation material should be applied.
 - If the wires are placed in the exterior or in places where they can be damaged or exposed to heat, humidity, dirt, etc., additional isolation should be applied and the wires should not be loose.
 - Wires cannot be connected to the board computers or control units.

- Connecting power source
 - Be sure that after the car computer goes to sleep mode, power might be still available on

the power wires. Depending on car, this may happen in 5 to 30 minutes period.

- When module is connected, measure voltage again to make sure it did not decrease.
- It is recommended to connect to the main power cable in the fuse box.
- 3 A, 125 V external fuse shall be used.

- **Connecting ignition wire**

- Be sure to check if it is a real ignition wire i. e. power does not disappear after starting the engine.
- Check if this is not an ACC wire (when key is in the first position, most of the vehicle electronics are available).
- Check if power is still available when you turn off any of vehicles devices.
- Ignition is connected to the ignition relay output. As alternative, any other relay, which has power output when ignition is on, may be chosen.

- **Connecting ground wire**

- Ground wire is connected to the vehicle frame or metal parts that are fixed to the frame.
- If the wire is fixed with the bolt, the loop must be connected to the end of the wire.
- For better contact scrub paint from the spot where loop is going to be connected.

PAY ATTENTION! Connecting the power supply must be carried out in a very low impedance point of on-board vehicle network. These points in the car are the battery terminals. Therefore, we recommend connecting the power of FMC920 (GND and POWER wires) directly to the battery terminals. Another valid option is to connect the wires to the main POWER cable inside the fuse box (if there is none, then to the power supply where the fuses of vehicle's computer are), GND wire must be connected in a special point, designed to connect GND vehicle computer. Connecting the GND at an arbitrary point to the mass of the car is unacceptable, as static and dynamic potentials on the line GND will be unpredictable, which can lead to unstable FMC920 operation and even its failure.

Installation photos

FMC920 is the device that has internal GNSS and GSM antenna.

Device should be mounted with the sticker view to the open sky (metal free). FMC920 area with sticker is shown in figure below:



FMC920 can be mounted under the plastic panel behind the front window, with the sticker direction to a window (sky). It is recommended to place FMC920 behind dashboard as close to the window as possible. A good example of GNSS antenna placement is displayed in a picture below (area colored green).

SIM card should be inserted in the module while the connector is plugged off (while module has no power).

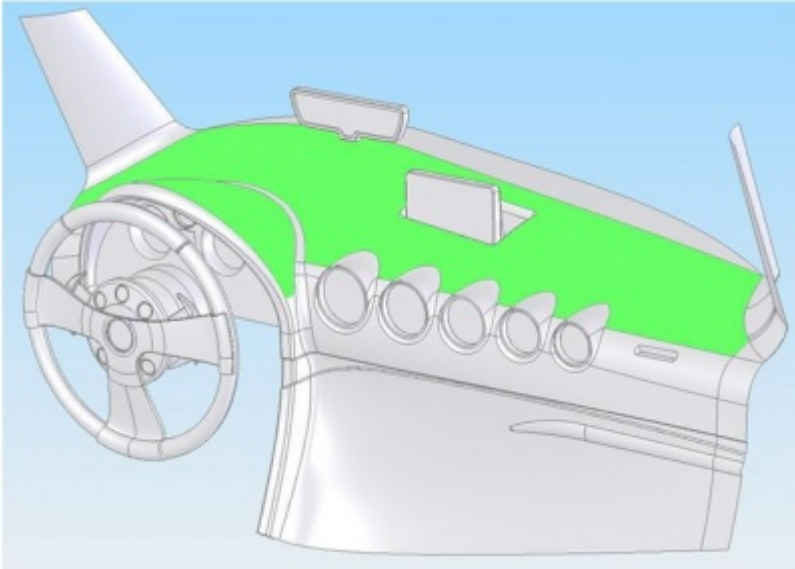

Safety information

This message contains information on how to operate FMC920 safely. By following these requirements and recommendations, you will avoid dangerous situations. You must read these instructions carefully and follow them strictly before operating the device!

- The device uses SELV limited power source. The nominal voltage is +12 V DC. The allowed voltage range is +10..+30V DC.
- To avoid mechanical damage, it is advised to transport the device in an impact-proof package. Before usage, the device should be placed so that its LED indicators are visible. They show the status of device operation.
- When connecting the connection (1x5) cables to the vehicle, the appropriate jumpers of the vehicle power supply should be disconnected.
- Before unmounting the device from the vehicle, the 1x5 connection must be disconnected.
- The device is designed to be mounted in a zone of limited access, which is inaccessible to the operator. All related devices must meet the requirements of EN 60950-1 standard.
- The device FMC920 is not designed as a navigational device for boats.

Precautions

- Do not disassemble the device. If the device is damaged, the power supply cables are not isolated or the isolation is damaged, DO NOT touch the device before unplugging the power supply.**
- All wireless data transferring devices produce interference that may affect other devices which are placed nearby.**
- The device must be connected only by qualified personnel.**
- The device must be firmly fastened in a predefined location.**
- The programming must be performed using a PC with autonomic power supply.**
- The device is susceptible to water and humidity.**
- Installation and/or handling during a lightning storm is prohibited.**